

SensoryOne Products Catalogue

6

Providing for people's special and additional needs.

A complete service for soft play, sensory equipment and environments.



Contents

Multi-Sensory Rooms	3	All Things Tactile	36-41 43-46
Sensory Studios®	4-5	Projection and Light Effects	42 92
Sensory Vehicles	6	Sensory Learning	47-51
Interactive Projection Systems	7-8	Loopies Liquid Floor Tiles & Discs	53-54 54-55
Mobile Sensory Carts	9	Sensory Integration	56-64
Bubble Tubes Bubble Walls and Accessories	10-16 17	Cushions and Supports	65-70
Plug Options	18	Soft Play	71-79
Switches	19-21	Opti Projectors and Visual Effects	80-91
	22-26		
Fibre Optic Lights Color Change Lights	27-32		
Sound & Light	33-35		

Multi-Sensory Rooms



Multi-Sensory Rooms evolved from the Dutch concept of Snoezelen in the 1980s.

The concept is to create events focused on particular senses such as feel, vision, sound, smell and taste as well as the more abstract senses of wellbeing, space, time, togetherness and many more.

A Multi-Sensory Room is a special place where the participant feels entirely at ease and able to initiate and control effects and the experience created. This is achieved in a host of different ways; through special sound and visual effects, tactile experience, vibration, use of aroma and music either independently or in combination.

Participants can achieve a liberating sense of control, often for the first time in their lives, and this empowerment offers huge opportunities for learning, relaxation and communication.

The use of multi-sensory practice continues to evolve and reach new audiences with every passing year. Successfully implemented in both mainstream and special educational settings, Sensory Rooms are now a trusted resource for residential and dementia care as well as private, community and respite projects.

Irrespective of the aim or audience, it is important to approach the project logically and with care to ensure a considered, appropriate, effective environment is designed and built.

Sensory Studios®



Sensory Studio®. A space of infinite possibility.

Tailor your sessions to be truly immersive or simply focus on a specific sense or single objective.

Sensory Studios® are now included in many mainstream schools as well as schools for pupils with special and additional needs. They have been developed to meet the demand for more flexible spaces which enable the users to create whatever type of environment or mood they wish, either temporary or permanent.

The Sensory Studio® allows appropriate interactivity by people of all cognitive and physical abilities. They are used for curriculum work at all levels, drama and creative arts, as themed environments, for communication and pastoral work, as well as for specific therapy and assessment.

The Sensory Studio® can be a relaxing and fun environment to explore and experiment in. It encompasses all of the possibilities that current technologies offer, an environment in which you can experiment with and exploit lots of physical materials and low-tech experiences.

Most importantly, Sensory Studio® control systems allow the user to have complete control of their environment and all of the equipment in it... very simply.

The Sensory Studio® can be controlled in a number of ways at any time:

- Manually, by direct interaction with equipment, or by plugging in Switches.
- Radio remotely, switching and interacting with equipment wirelessly via Transmitters
- With dynamic interactive projection (for some elements of the Studio)

The basic elements of a Sensory Studio® are:

A flexible shell, open space or blank canvas that can be reshaped with equipment and effects to create or influence whatever mood, experience, theme or scenario for group or individual use is required, and change it as the theme develops.

A flexible and easy-to-use control system which can be used by anyone, anywhere, and which adapts as technology develops.

An environment which can grow and change as individual needs evolve and to incorporate new equipment and ideas.

Adequate storage and shelving.

Easy access for setting up and maintenance.

Plenty of low-tech materials and disposal elements to use and experiment with.

The typical uses of a Sensory Studio® are:

Drama, create stage sets and changing scenes, for audience participation. It allows complete integration of mainstream and special needs curriculum work.

Theme work, creating any sort of scene, such as seasons, travel, space, curriculum topics and dramatic events in which participants can interact at their level of functioning or skill.

Individual choice and control, enables anyone of any ability to select and control their environment, express likes and dislikes, understand freedom of choice and learn skills for independence and inclusion.

Learning specific skills, such as cause and effect, visual tracking, listening and communication and all the skills needed for learning.

Curriculum work across a broad spectrum of subjects, for example; science, maths, literacy, drama, physical education, history and social sciences. The Sensory Studio® enhances opportunities for mainstream students too, enabling everyone to participate on equal terms.

To arrange a visit to discuss your studio project, call us at 1 877 232 3320 or email, customerservice@sensoryone.com

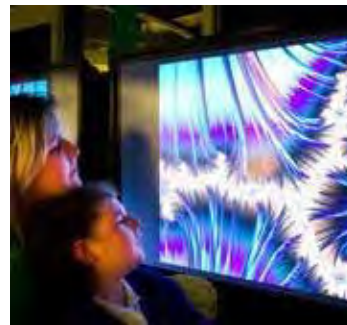

Sensory Vehicles

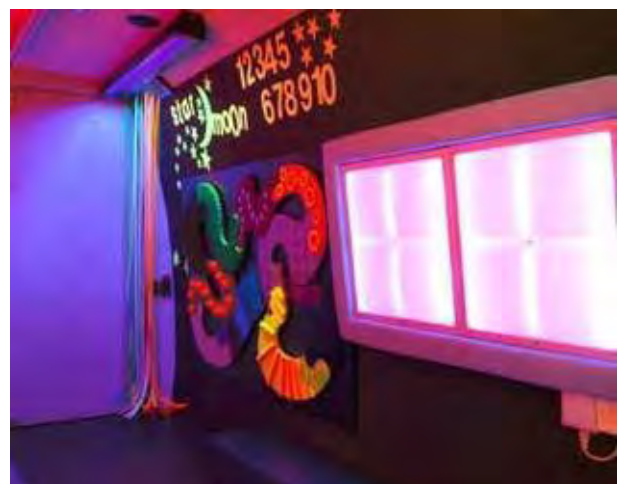
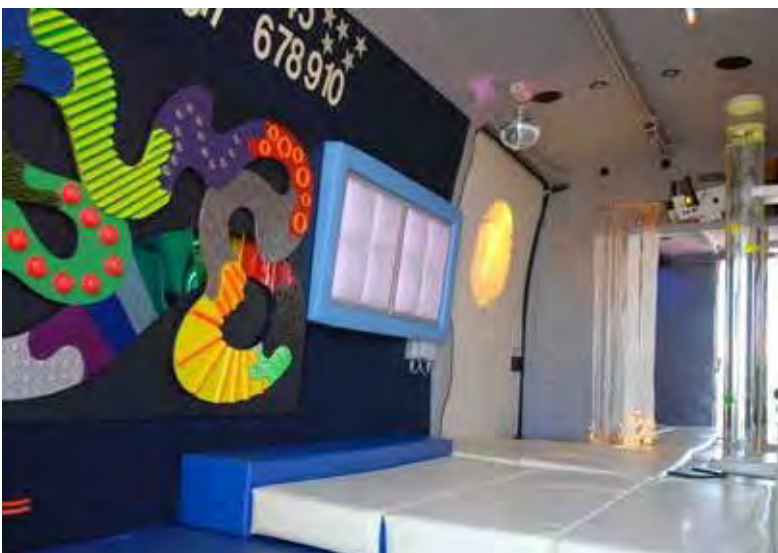

omiVista Interactive Projection Systems

NO SUBSCRIPTIONS OR LICENSE FEES

OMI is a motion-activated interactive projection system for all ages and abilities, especially those with dementia/cognitive decline, developmental disabilities and autism spectrum users.

Available with two versions: 1. The Flagship omiVista; 2. The Budget-Friendly Budii (see next page)

omiVista Key Features Include

- **No subscription fees** for the **life** of the unit
- **No maintenance** required for **life** of the unit
- **Self-calibrating** for easy projection surface changes
- Comes **fully assembled** out of the box
- High-intensity laser **LED lens** (no replacement) with bright, sharp projection even in well-lit areas
- **Antibacterial high gloss finish**
- **No internet required; plug-and-play** (standard wall outlet)
- **Customizable** (Upload personal images, videos and music)
- Includes Sensory Suite (**300+ activities**); optional Autism & Dementia suites available
- Promotes social & intergenerational interaction



OMIVISTA MOBII

(Mobile unit for floor or table top projection)

The mobile Mobii is the flagship omiVista model enabling greater flexibility of use.

Features:

- 4 locking wheeled platform
- Self-contained with image suites preloaded
- Electronically height adjustable with the push of a button
- Adjust projector height to match the size of the projected surface



OMIVISTA WALL

(Ceiling mounted for wall projection)

The omiVista Wall projects captivating, dynamic interactive images directly onto the wall for consistent, dedicated projection.

Features:

- Ceiling mounted
- Interactive images projected directly onto the wall
- Ideal where floor space is limited or wall projection is preferred



OMIVISTA INSTALL

(Fixed ceiling install for floor/table projection)

The Install model is ceiling mounted and automatically calibrates for projection downward onto tabletops or floors.

Features:

- Automatically calibrates for consistent projection between surfaces
- Ideal for dedicated areas where user damage to the machines is a possibility or where floor space is at a premium

Budii Interactive Projection Systems

NO SUBSCRIPTIONS OR LICENSE FEES

Budii is a budget-friendly interactive projection model for all ages and abilities, ideal for play, therapy and rehabilitation—especially for autism and cognitive conditions such as dementia.

Omi BUDII Key Features Include

- **No subscription fees** for the **life** of the unit
- **No maintenance** required for **life** of the unit
- **Self-calibrating** for easy projection surface changes
- **Compact, lightweight** and **easy** to use
- High-intensity laser **LED lens** (no replacement) with bright, sharp projection even in well-lit areas
- **No internet required; plug-and-play** (standard wall outlet)
- Standard Sensory Suite with **300+ Activities (Budii Flip Only)**
- **Optional Specialized therapeutic Image Suites for Autism and Dementia**
- Promotes social & intergenerational interaction



BUDII

(Standard fixed wall/ceiling mounted)

Wall installation projects downward only onto tables or floors. Ceiling (or shelf) installation also allows wall projection.

Features:

- Ideal for multi room use
- All activity suites are preloaded



BUDII MOBILE

(Mobile unit)

A budget-friendly wheeled manual height-adjustable stand for system mobility.

Features:

- Adjust projected image size to match the surface
- Ideal for multi room use
- All activity suites are preloaded



BUDII FLIP

(Multi-surface mobile projection system)

Has a premium mobile stand with electric-powered height adjustment allowing the projector to rotate and project onto every surface.

Features:

- Projection unit rotates to project onto the floor, tabletops, walls and ceiling without the need to recalibrate the camera
- Electric height adjustment stand to match the image size to the projecting surface
- All activity suites are preloaded

Mobile Sensory Carts

Discover the flexibility of mobile sensory carts

- Transform any room into an immersive sensory environment.
- Designed for schools, therapy centers, hospitals, care homes and community programs.
- Plug-and-Play feature enables tactile, visual and auditory stimulation anywhere.
- Customizable to meet your needs and budget

Available in two models:

- VOYANTA ONE (budget-friendly starter)
- VOYAGER (deluxe cart)

VOYANTA ONE SENSORY CART



VOYANTA ONE

The VOYANTA ONE is a **budget-friendly modular cart** featuring a **new interactive solar panel**, **lockable storage** and **high-end mobility**.

The perfect solution to turn any space into a portable sensory room.

Key Features:

- Customize your cart with additional products to meet your needs and budget
- Bubble Tube (auto color change setting, optional manual color changing with separate switches)
- Birch plywood with a clear lacquer finish
- Unique integrated voice and touch activated tactile solar panel
- Industry grade four way swivel castors (2 locking brakes)
- Large lockable storage and pre-drilled cable conduits
- One single standard household power plug

Optional accessories:

- Fiber Optic Side Glow lighting with 200 x 2m/72" tails
- Mirror Ball/Pin spot light source
- Selection of Image Projectors
- Low Profile or Nine Color Keyboard color changing switches

VOYAGER SENSORY CART



VOYAGER

The VOYAGER is a deluxe cart. An excellent alternative to a formal sensory room.

The VOYAGER's **modular design and portability** make it ideal for schools, care facilities, hospitals, libraries, museums, medical offices as well as at home.

Key Features:

- Customizable with additional products to meet your needs and budget
- Tall front folding mirrors reflect the bubble tube creating a multi-tube illusion
- Bubble tube with auto color change setting or manual color selection with the handheld color controller)
- Slim profile and single standard household power plug
- Extensive lockable storage cabinet and dust cover included

Optional accessories:

- Fiber Optic Side Glow lighting with 200 x 2m/72" tails
- Mirror Ball/Pin spot light source
- Selection of Image Projectors
- Multi Button Handheld Color Change Controller

Bubble Tubes

Compare the Bubble Tubes



5" (12cm)

Small



6" (15cm)

Standard



8" (20cm)

Large



12" (30cm)

Giant



20" (50cm)

Ultra Giant

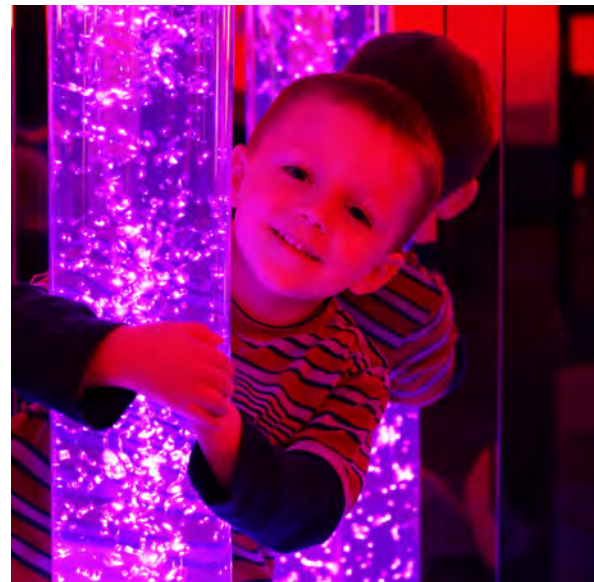

Bubble Tubes

Bubble Tubes are one of the most universally popular pieces of equipment in any Sensory or Relaxation Room and has a wide range to choose from.

The bright changing colored bubbles rise through the column of water and create a fascinating visual experience with a relaxing sound and vibration.

They create a center piece to focus on when rooms are used for relaxation and offer a spectacular reward when used in a structured way for cause and effect or curriculum based activities.

We have been designing and manufacturing our own Bubble Tubes for many years and have been at the forefront of many new developments.

Recent innovations have included the Giant and Ultra-Giant Bubble Tubes.

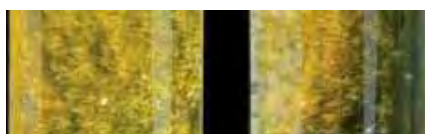

The features of our Bubble Tubes include:

8 color changes: A bright spectrum of 8 clear colors which gently change when used passively.

Instant control: Use any switch to step through the colors or select and mix them, instantly.

Easy Switch: Control in its simplest form, plug switches directly into the Bubble Tube to switch and mix colors.

Easy Access: the uniquely designed base is very compact and allows users to sit or lay around the Bubble Tube without the need for a platform or other raised plinth. It gives close wheelchair access, allowing the user to touch and cuddle the tube. Removable Bubble Tube Surround Cushions and Bean Cushions are available.

LED Lights: All of our Bubble Tubes are illuminated with LED lights which have precise color balance as well as being extremely bright and very long lasting. (You will never have to replace a lamp again).

Standard Bubble Tubes: All Standard Bubble Tubes are 15 cm (6") in diameter. This includes Ball Bubble Tubes and Square Based ones.

Large Bubble Tubes: These were introduced in our last catalogue. They are 20 cm (8") in diameter and give a much bigger visual effect than the standard ones. They can be used passively and have Easy Switch Interactive Control.

Giant Bubble Tubes: They are a truly enormous 30 cm (12") diameter and give a spectacular effect, which is possible due to their unique design. They can be used passively and have the Easy Switch Interactive Control.

Ultra Giant Bubble Tube: These are MONSTERS! 50 cm (20") in diameter and immensely impressive, they are particularly suited to large spaces.



Bubble Tubes



Ball Bubble Tubes – 6” (15cm) diameter

Featuring all the functions and benefits of standard Bubble Tubes, with the addition of a second, inner tube that allows the colored balls to rise and fall slowly within the water, Ball Bubble Tubes enable you to play games with the bubbles and movement of the balls.

Particularly good for encouraging vertical visual tracking. They come in three different heights; 59” (1.5m), 69” (1.75m) and 79” (2m).

Square Base Ball Bubble Tubes

Code	Product
1927-015	Ball Bubble Tube – Easy Switch – 59” (1.5m)
1927-017	Ball Bubble Tube – Easy Switch – 69” (1.75m)
1927-020	Ball Bubble Tube – Easy Switch – 79” (2m)



Small Passive Bubble Tube 12 cm (5") Diameter

Although we call this our “Small Bubble Tube”, at 1.12 m (3.7 ft) high and 12 cm (5") diameter, it is larger than anyone else’s Small Bubble Tube. An economic basic Passive Bubble Tube that is ideal for home use. Plugs into any 13amp socket with a safe 12 volt power supply into the base of the tube. It can be switch controlled via a Switch2 Control Unit.

Code	Product
1926-430	Small Passive Bubble Tube



Bubble Tubes



Standard Bubble Tubes 15 cm (6") Diameter

This is the traditional diameter Bubble Tube that is used in most Sensory environments and gives an impressive visual reward when used passively or with interactive control.

All our Bubble Tubes now use LED color change technology that is a brighter, purer color, uses less energy and is more controllable. You will also never need to buy another replacement bulb. We also have 'soft color change' which means that there are no scary flashes when it changes from one color to another.

They come in four different heights; 1.0 m (3.3 ft), 1.5 m (5.0 ft), 1.75 m (5.75 ft) and 2.0 m (6.5 ft), and have a diameter of 15 cm (6").

Square Base Bubble Tubes

Code	Product
1926-010	Bubble Tube – Easy Switch – 1.0 m (3.3 ft)
1926-015	Bubble Tube – Easy Switch – 1.5 m (5.0 ft),
1926-017	Bubble Tube – Easy Switch – 1.75 m (5.75 ft)
1926-020	Bubble Tube – Easy Switch – 2.0 m (6.5 ft),



Large Bubble Tubes 20 cm (8") Diameter

Large Bubble Tubes come in three different heights; 1.5 m (5.0 ft), 1.75 m (5.75 ft) and 2.0 m (6.5 ft)

Square Base Large Bubble Tubes

Code	Product
1928-015	Large Bubble Tube – Easy Switch – 1.5 m (5.0 ft)
1928-017	Large Bubble Tube – Easy Switch – 1.75 m (5.75 ft)
1928-020	Large Bubble Tube – Easy Switch – 2.0 m (6.5 ft)

Bubble Tubes



Giant Bubble Tubes 30 cm (12") Diameter



This new diameter offers a spectacular effect with brilliant color. Offering an impressive focal point for any room or public area. Featuring a fast flow tap, the tube benefits from easy filling and emptying too.

The Giant Bubble Tube comes at 2.0 m (6.5 ft) tall.

Code	Product
1851-120	Giant Bubble Tube – Easy Switch – 2.0 m (6.5 ft)

Ultra Giant Bubble Tube 20" (50cm) diameter

An astonishing feature for any space or environment the Ultra-Giant tubes are a pioneering development. Supported by a fast flow tap for trouble free filling and emptying, Ultra Giant tubes contain a similar volume of water to the 50 cm (20") diameter tubes.

Custom padded bases can be manufactured to suit your needs, and the tube could be as tall as 2.0 m (6.5 ft).

Code	Product
2350-520	Ultra Giant Bubble Tube – 2.0 m (6.5 ft)



Bubble Walls and Accessories

Flat Bubble Walls



A wonderful alternative to a Bubble Tube, where space or extremely robust use may be an issue, or you just want a different sort of effect. Brightly colored bubbles make intriguing shapes and patterns that rise through the wall. The panel can be used passively with the colors changing by gently fading into each other, or interactively for cause and effect, color mixing and other games.

There are 3 standard heights available.

- 43" (110cm), 55" (140cm) and 75" (190cm), actual screen height. Overall wall sizes: 53" x 28" x 4" (134cm x 72cm x 10cm), 65" x 28" x 4" (164cm x 72cm x 10cm) and 84" x 28" x 4" (214cm x 72cm x 10cm) respectively.

Code	Product
1852-011	Bubble Wall – Easy Switch – 43" (110cm)
1852-014	Bubble Wall – Easy Switch – 55" (140cm)
1852-019	Bubble Wall – Easy Switch – 75" (190cm)
1852-111	Bubble Wall – S4 Interactive – 43" (110cm)
1852-114	Bubble Wall – S4 Interactive – 55" (140cm)
1852-119	Bubble Wall – S4 Interactive – 75" (190cm)

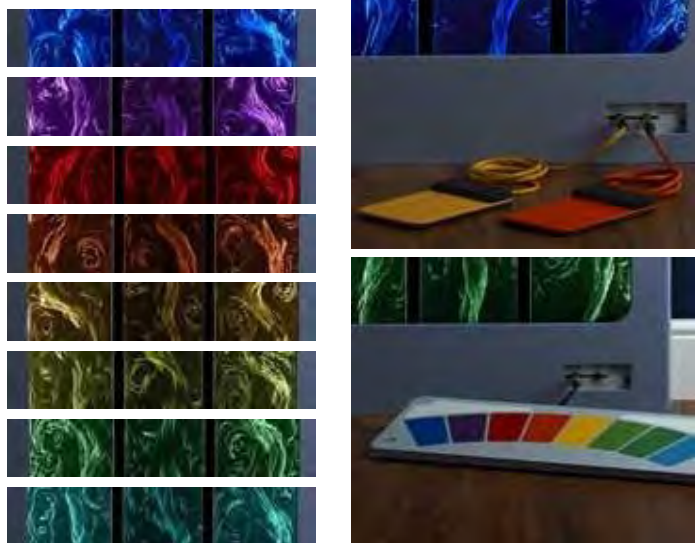

Bubble Tube Bracket



A discreet and secure bracket to fix tall Bubble Tubes to the wall and make them safe for people to lean on or pull with their whole weight (depending on the strength of the wall).

Note: All Bubble Tubes higher than 39" (1m) should be fixed to the floor and have a bracket near the top.

Code	Product
1926-901	Bracket for Standard Bubble Tube – 6" (15cm)
1928-902	Bracket for Large Bubble Tube – 8" (20cm)
1851-903	Bracket for Giant Bubble Tube – 12" (30cm)

Bubble Tube Spares and Accessories

Below is a list of basic spares. If you require any other components or advice about your bubble tubes, please contact us at 1 877 232 3320.

Code	Product
0733-101	Replacement Lamp – FTE 12v 35w 5000 hour life (for old type bubble tube)
1926-921	Replacement End Cap for Standard Bubble Tube
1928-922	Replacement End Cap for Large Bubble Tube
1851-923	Replacement End Cap for Giant Bubble Tube
1926-931	Replacement Air Pump
1926-932	Replacement Solenoid Valve
	Other parts – Phone for details

Plug Options

Easy Switch

A fully integrated switching system that works together, perfectly.

Enabling anyone of any ability to control equipment and their environment is an essential right and a means to access, learning, communication and enjoyment.

Simple switches are still as relevant today as the latest mobile technology. Therefore, we now have 2 levels of control for our fully integrated Multi-Sensory Equipment.

These levels of control work seamlessly together and therefore any piece of equipment works for each individual person using it in a way to suit them.



Easy Switch

The most basic Control System – Plug single Switches directly into the equipment. Use 1 or 2 Switches or a Nine Switch Keyboard.

Step through colors, select color, bubbles, and ON / OFF options.

Switches

Extremely well made, reliable and robust switches



Switches you use are the most important component for controlling equipment. They need to be completely reliable, be accessible, and work in a way that your abilities comfortably allow.

Some people need to work towards the understanding that the Switch is the means of accessing any equipment or effect. For others, it is an essential tool for access and communication.

Where people have precise or complex needs it is best to work with a professional adviser or therapist to choose the most appropriate Switch available.

Nine Switch Keyboard

Part of an incredibly versatile switching system, the Keyboard's low profile design and touch sensitive switch area follows the arc of natural hand movement. This ergonomic design helps make it suitable for people with limited dexterity.

The Keyboard functions as 1,2,4,8, or 9 switches and is supplied with three tough plastic overlays to show the active switch areas. Designed for use with a number of pieces of equipment such as the LED Color Change Light Kits, Shapes Infinity Panel and an increasing range of equipment as they are upgraded and new products emerge.

Features include:

- 1,2,4,8 or 9 Switch Keyboard (selected by a simple slide switch)
- Tough plastic overlays attached by Velcro dots
- Touch sensitive switch areas, no pressure needed
- Select silent or audible 'click' when switch is activated
- No batteries needed
- Has a compartment to tuck cables and the Universal Transmitter into while in use, thus making it tidy and compact.



Code	Product
0765-509	Nine Switch Keyboard (23" x 9.5" x 2") (59cm x 24.5cm x 5.5cm)
0765-510	Set of 3 Replacement Overlays

*Please note Transmitter not included.



Low Profile Switches



A large hand-sized press switch plate, which is very sensitive and gives a positive 'click' when activated. Being only 3/8" (10mm) thick it is easy for people with limited hand movement to use.

It is extremely strong with virtually indestructible cords and plugs. We use the best quality materials and components available and matching colored screened cable, for safety and ease of use. There are now nine colors, with the option of 157" (4m) long cords now available.

Code	Product
0765-010	Low Profile Switch – Yellow
0765-011	Low Profile Switch – Red
0765-012	Low Profile Switch – Green
0765-013	Low Profile Switch – Blue
0765-014	Low Profile Switch – White
0765-025	Low Profile Switch – Orange
0765-026	Low Profile Switch – Lime
0765-027	Low Profile Switch – Turquoise
0765-028	Low Profile Switch – Purple
0765-110	Set of 4 Low Profile Switches – Basic colors
0765-111	Set of 4 Low Profile Switches – Secondary colors

Low Profile Switches with 157" Cords



Made to the same high quality as the standard Low Profile Switches but with 157" (4m) long cords. Initially made on request for use with the Soundbeam® and for people in wheelchairs to access some equipment more easily, they can be used with any switchable equipment.

Code	Product
0765-410	Low Profile Switch – 157" (4m) cord – Yellow
0765-411	Low Profile Switch – 157" (4m) cord – Red
0765-412	Low Profile Switch – 157" (4m) cord – Green
0765-413	Low Profile Switch – 157" (4m) cord – Blue
0765-414	Low Profile Switch – 157" (4m) cord – White
0765-425	Low Profile Switch – 157" (4m) cord – Orange
0765-426	Low Profile Switch – 157" (4m) cord – Lime
0765-427	Low Profile Switch – 157" (4m) cord – Turquoise
0765-428	Low Profile Switch – 157" (4m) cord – Purple
0765-420	Set of 4 Low Profile Switches Basic colors – 157" (4m) cords
0765-421	Set of 4 Low Profile Switches Secondary colors – 157" (4m) cords



A Nine Switch Keyboard being used to control the colors and bubbles in a Bubble Tube.

The Nine Switch Keyboard can be used to operate a wide range of design equipment.

Color Change Lights



LED Color Change Lights

Control them with physical switches.

Complete and instant control of the color of any room, just by the touch of a switch.



Colored LED lights can be used to change the color of any space and in doing so dramatically influence the atmosphere of an entire environment.

We use Floodlights, Washes, Spots and Panels or a combination of different fittings, depending on the environment and the effect desired.

Features include:

- Touch sensitive Switch Control for everyone regardless of their ability
- Operate manually with any type of single switch or with a Nine Switch Keyboard and a fixed Wall Keyboard Switch
- Eight standard colors and white with a one-touch adjustment to achieve any color in the visible spectrum
- Brightness adjustment of the colors
- Three adjustable passive programs and five switch-controllable programs
- Color mix by touching any two basic colors to get the mixed, secondary color
- A completely controllable and spectacular 'rainbow' light effect program

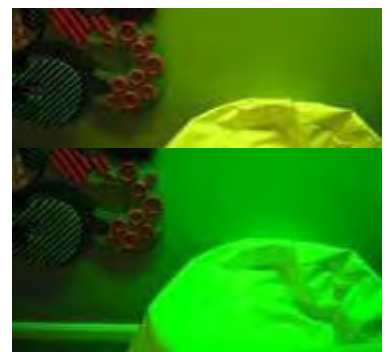
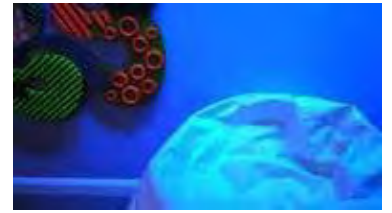



LED Color Change Floodlights



The Floodlight Kits work in exactly the same way as the other Color Change Lights, including all 8 interactive programs. They will create large pools of color on whatever surface they are aimed towards. Great for spaces with multiple surfaces or if you want to color a specific area of a room.



Code	Product
1392-142	2 Light LED Floodlight Kit
1392-144	4 Light LED Floodlight Kit
1392-146	6 Light LED Floodlight Kit
1392-148	8 Light LED Floodlight Kit
1392-140	Other specific LED Floodlight Kits



Color Change Lights



Mood Light Sphere and Cube

These strong illuminated hollow plastic forms are aesthetically pleasing objects and can be placed around the room or used in a Sensory Hut to provide mood lighting. You can choose one of a wide range of different colors or set them to fade smoothly through the entire spectrum of shades, from a cool ultraviolet to a warm red. The Sphere and Cube are powered through a base plate with a safe low voltage electrical power supply. When disconnected they can be used wherever required and will give up to 10 hours of light. The units are water resistant rated IP65 and can be used in Sensory Pools or outdoors.

Sizes: Spheres 10" (25cm), 16" (40cm) and 24" (60cm) diameter. Cube 16" x 16" x 16" (40cm x 40cm x 40cm)

Code	Product
2561-025	Mood Light Sphere – 10" (25cm)diameter
2561-040	Mood Light Sphere – 16" (40cm)diameter
2561-060	Mood Light Sphere – 24" (60cm)diameter
2561-140	Mood Light Cube – 16" x 16" x 16" (40cm x 40cm x 40cm)



LED Strip Light Kits



For color washing walls and surfaces as well as creating wonderful color mood within any room. All kits include: light fittings, an Interactive Controller, cables and power supply.

IP rated systems can be supplied for use in pool and outdoor areas.

Code	Product
1392-012	LED Strip Light Kit 47" (120cm)
1392-016	LED Strip Light Kit 63" (160cm)
1392-024	LED Strip Light Kit 94" (240cm)
1392-032	LED Strip Light Kit 126" (320cm)
1392-036	LED Strip Light Kit 141" (360cm)
1392-048	LED Strip Light Kit 189" (480cm)
1392-099	LED Strip Light Kit – special lengths



Wall Keyboard Switch



It has the same basic functions as the Nine Switch Keyboard, but is designed to fix very securely to the wall. It is an extremely robust, touch sensitive switch control panel for any LED based Color Change lights.

It can also be used with the Interactive Bubble Tube, Interactive Fiber Optic Lights, and a range of other equipment. It gives one touch control of eight colors and then a second touch can shift to any shade of color on the spectrum.

Size: 23" x 9" x 1/2" (59cm x 23.5cm x 1.5cm)

Code	Product
0765-512	Wall Keyboard Switch



Nine Switch Keyboard



The Nine Switch Keyboard is part of the Switch2 system. It is low profile with an arc of touch sensitive switches. It can be a Keyboard with 1,2,4,8 or 9 switches and has tough plastic overlays to facilitate this.

It also has a compartment to tuck away cables and the Universal Transmitter, so nothing is exposed while it is in use.

(See page 36 for full details)

Code	Product
0765-509	Nine Switch Keyboard
0765-510	Set of 3 Replacement Overlays



Color Change Lights



Rainbow Light Bar



With 8 LED Color Change Lights and Interactive control, the Rainbow Light Bar creates wonderful moving rainbows of colored light.

Complete and instant control of the color of any Sensory Room, just by the touch of a Switch. It will color wash walls and surfaces giving color mood within any room.

Features include:

- Controllable by everyone with almost any type of single Switch or Nine Switch Keyboard
- Can be controlled with a fixed Wall Mounted Keyboard Switch
- Eight standard colors and white with a one-touch adjustment to any color in the spectrum
- Brightness adjustment of the colors
- Three adjustable passive programs and five switch controllable programs
- Color mix by touching any two basic colors to get the mixed secondary color
- A completely controllable and spectacular 'rainbow' light effect program

The Wall Keyboard Switch must be purchased separately.

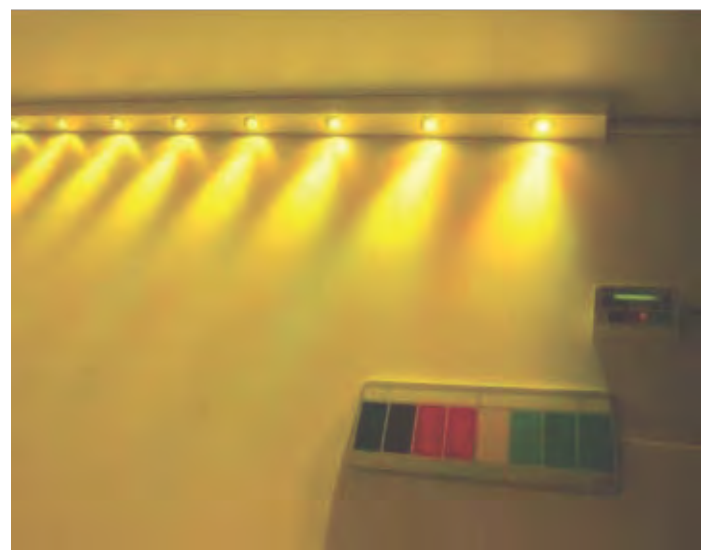

Code	Product
2280-030	Rainbow Light Bar – 118" (300cm) long
2280-031	Linked Rainbow Light Bar (without Controller)
2280-039	Rainbow Light Bars can be made any length between 6.5 (2m) and 9 ft (3m). Please specify length.
0765-512	Wall Keyboard Switch

Fiber Optic Lights



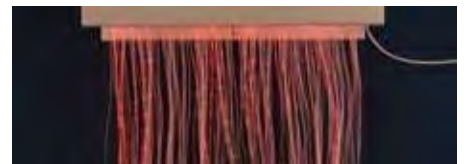

Fiber Optic Sideglow Cascade



A relaxing visual effect, offering opportunity for interaction and interest for people with profound difficulties. 180 tails of light cascade to the floor in a waterfall of ever changing colors. The light glows through strands of translucent plastic that you can lie amongst and handle. Powered by our LED Light Source, the colors are crisp, bright, controllable and you never need to replace a lamp. Everything is contained within an attractive wall mounted box.

There are two versions available, one is Easy Switch, which has two switch plates and jack sockets for external switches. Simply plug in a single switch for on/off and to step through colors or a Nine Switch Keyboard to select and mix the eight colors. When the switches are not attached, it gently cycles through the colors.

The second, the Interactive version allows you to have complete control of the colors in 7 different modes and programs, some passive and some interactive.



Code	Product
1280-015	Easy Switch Sideglow Light Cascade





Easy Switch Fiber Optic Sideglow Light Source

The brightest and most controllable LED Light Source available.

This is a new generation of controllable Light Sources. It takes full advantage of LED technology. Brighter, quieter, smaller, cooler and offering complete control of a range of eight colors and what's more, you never have to buy a replacement bulb.

The Easy Switch LED Light Source emits colored light up to the equivalent of an 80 watt bulb of pure color. It gently cycles through a sequence of eight colors, each color fading into the next, so there are no sudden and disturbing flashes when they change.

It includes two integral jack sockets, into which you can plug single switches to step through the colors and switch them on and off.

If you plug in a Nine Switch Keyboard, you can select and mix colors. When the switches are not in use, the Light Source reverts to passive color cycling.

Light Sources include a special safety feature that means that the LED light switches off when there is Fiber Optic tails plugged into them.

All standard 1"(30mm) diameter Fiber Optic Harnesses, from any manufacturer, will fit into our Light Sources.

Code	Product
1280-131	100 x 39" (1m) Plastic Sideglow Tails with Easy Switch LED Light Source
1280-132	100 x 79" (2m) Plastic Sideglow Tails with Easy Switch LED Light Source
1280-232	180 x 79" (2m) Plastic Sideglow Tails with Easy Switch LED Light Source
1280-233	180 x 118" (3m) Plastic Sideglow Tails with Easy Switch LED Light Source
1280-192	Replacement Power Supply for Easy Switch LED Light Source

Code	Product
1280-100	Easy Switch LED Fiber Optic Light Source (on it's own)
1280-111	100 x 39" (1m) Plastic Fiber Optic Sideglow tails (on their own)
1280-112	100 x 79" (2m) Plastic Fiber Optic Sideglow tails (on their own)
1280-182	180 x 79" (2m) Plastic Fiber Optic Sideglow tails (on their own)
1280-183	180 x 118" (3m) Plastic Fiber Optic Sideglow tails (on their own)

Fiber Optic Lights

Fiber Optic Sideglow Curtains



These Fiber Optic Tails create a gently changing and moving curtain of light that can be handled and moved through. They can be used in an entrance, to create a room division or as a feature in an activity area.

The Fiber Optic Curtain is available in a variety of widths and drops and is connected to a LED color controllable Light Source, which never needs lamps replacing.

There are two types of LED Light Sources available; Easy Switch, that can be connected to a Single or Double Wall Switch Plate. Or use a single Switch or a Nine Switch Keyboard to select and mix the eight colors. When no switch is attached the curtain gently cycles through the colors.

Interactive allows you to have complete control of the colors in 8 different passive and interactive programs. Use single Switches or a Nine Switch Keyboard.



Code	Product
1280-061	Fiber Optic Sideglow Curtain 79" (2m) drop x 39" (1m) wide with Easy Switch Light Source
1280-071	Fiber Optic Sideglow Curtain 79" (2m) drop x 39" (1m) wide with Light Source & Interactive Light Source
1280-062	Fiber Optic Sideglow Curtain 79" (2m) drop x 59" (1.5m) wide with Easy Switch Light Source
1280-072	Fiber Optic Sideglow Curtain 79" (2m) drop x 59" (1.5m) wide with Interactive Light Source
1280-063	Fiber Optic Sideglow Curtain 79" (2m) drop x 79" (2m) wide with Easy Switch Light Source
1280-073	Fiber Optic Sideglow Curtain 79" (2m) drop x 79" (2m) wide with Interactive Light Source
1280-069	Special size Fiber Optic Sideglow Curtain with Easy Switch Light Source
1280-079	Special size Fiber Optic Sideglow Curtain and Interactive Light Source
1280-114	Single Switch Plate and Socket – 13ft (4m) Cord
1280-124	Double Switch Plate (for Easy Switch light source)

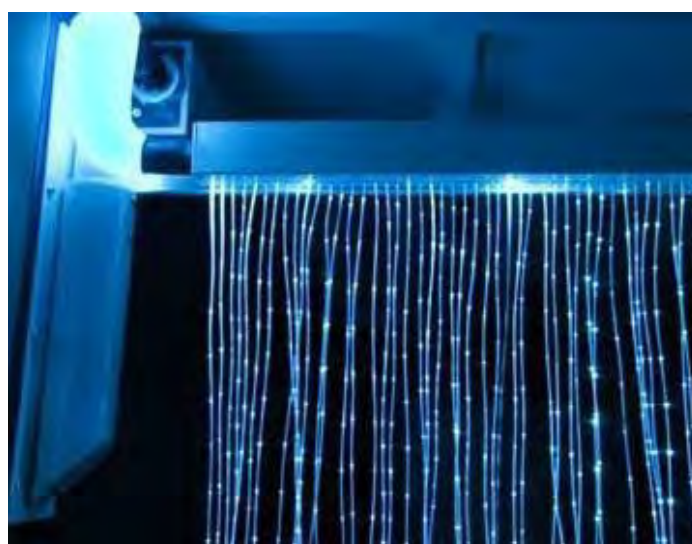

Heavy Duty Hinged Bracket for Fiber Optic Curtains



This is a specially designed swivel bracket that will hold most types of Fiber Optic Curtains. It swings in a 180 degree arc, runs on nylon bushes and is extremely robust if fixed to a solid wall. Made with powder-coated steel.

Code	Product
1280-091	Heavy Duty Hinged Bracket For 39" (1m) wide curtain
1280-092	Heavy Duty Hinged Bracket For 59" (1.5m) wide curtain
1280-093	Heavy Duty Hinged Bracket For specified width curtain (not wider than 59" (1.5m))



Fiber Optic Sideglow Shower



Ideal for creating a feature within a larger room, the Fiber Optic Sideglow Shower is similar to a Fiber Optic Curtain but is confined to a smaller area.

Ceiling suspended, the Sideglow Shower features either an Easy Switch or Interactive Light Source.

Size: 18" (45cm) diameter x 75" (190cm) drop.

Code	Product
1280-331	Fiber Optic Sideglow Shower with Easy Switch Control – 75" (190cm) drop



Sparkle Cloud

A wonderful cloud shape that is suspended below ceilings that may be cluttered, too high or simply boring. The Sparkle Cloud contains 200 points of gently changing colored lights, creating a galaxy of twinkling stars.

In large areas you can include a combination of Basic Clouds (without lights) and Sparkle Clouds.

Code	Product
1934-001	Sparkle Cloud 57" x 47" (145cm x 120cm) With Easy Switch Control
1934-011	Basic Cloud (no lights) 57" x 47" (143cm x 120cm)
1280-114	Single Switch Plate & Socket – 13ft (4m) cord
1280-124	Double Switch Plate & Sockets – 13ft (4m) cord



Wall Switch Plate - Easy Switch - Double

A large, low profile and robust wall switch plate with an integral jack socket which is designed for our Easy Switch range of equipment, it also enables you to plug in any other portable switch to use in that locality.

It is designed specifically to work with the LED Fibre Optic Light Source, making it ideal for fixed equipment such as the **Sparkle Clouds, Fibre Optic Curtains, Fibre Optic Carpets** and also with fixed Switch Control System

Designed by occupational therapists and sensory experts, these high-quality, durable, and user-friendly switches offer unique benefits for your sensory space

Plug a single switch into the 'step colour' socket and each time you activate the switch the colour will change. Plug another into the 'on-off' socket and the lights will stop and start with each touch of the switch.

The Double Socket allows you to control the ON/OFF and colour change functions at the same time.

Sound and Light



Shapes Infinity Panel

Control the magical effect of the most interactive Infinity Panel around in a host of different ways.

10 Interactive programs provide co-operative and competitive activities for up to 4 people as well as for visual, color, shape and communication work on a one-to-one basis.

It includes 12 programs; 2 passive and 10 interactive.

Four of the programs are basic 'Simon' games which give you different audio rewards as well as visual ones. This is wonderful for many types of skill learning while being great fun too.

The programs are selected via an easy to use menu and touch keys and the panel is activated by four large integral button switches or via Switches plugged into the jack sockets.

Size: 34" x 29.5" x 3" (87cm x 75cm x 8cm) (wall mounted).



Code	Product
0831-002	Shapes Infinity Panel (with 4 shapes)

Sound and Light



NEW – Sound and Light Floors



Wonderfully interactive, the Sound and Light Floor is instantly responsive to the most sensitive touch and yet can be jumped on by the heaviest adult or trundled over by people in wheelchairs.

A range of built-in activities and games encourage individual and collaborative interaction, each with different levels of difficulties. The Sound and Light Floor is designed for use by anyone of any ability, from the most dependent child to the most energetic adult athlete.

Spectacular colored panels light up and provide clear notes and sounds just by laying or rolling on them, while more able users are challenged by activities requiring greater dexterity and energy. The 'Simon' game challenges both your dexterity and memory.

Features:

- 8 Interactive and passive activities with setting variations
- 16 different Instrument and Sound options
- Volume control
- Adjustable timer for completion of games and levels
- Responsive to fingertip touch and robust, energetic use
- No lamp failures, LED Technology
- Only 1.5" (4cm) DEEP!
- 9, 12 or 16 panel floors as standard options
- Larger custom sizes can be supplied
- Tapered surround for easier access or built in to floor for optimum finish

Sizes (without surround):

9 panel floor – 46" x 41" x 1.5" (116cm x 104cm x 4cm) deep
 12 panel floor – 46" x 54" x 1.5" (116cm x 137cm x 4cm) deep
 16 panel floor – 54" x 59" x 1.5" (137cm x 149cm x 4cm) deep
 Minimum surround size: add 10" (25cm) to each of the first two dimensions.

Code	Product
2031-009	Sound and Light Floor – 9 panel
2031-012	Sound and Light Floor – 12 panel
2031-016	Sound and Light Floor – 16 panel
2031-101	Surround for Sound and Light Floor Made to fit your space



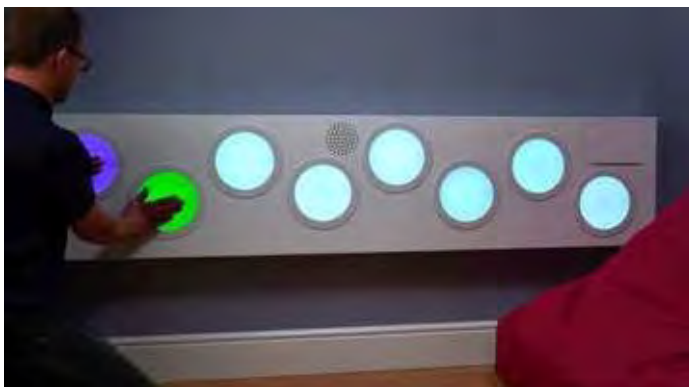
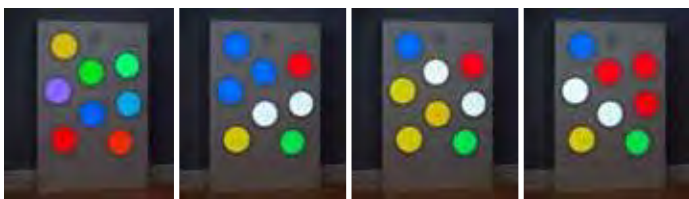

NEW – Touch, Sound and Light Panels



This wonderfully interactive panel is instantly responsive to the most sensitive touch.

A range of games encourage individual and cooperative interaction, each with different levels of difficulties. The Panel is designed for use by anyone of any ability, from the most dependent child to the most disruptive adult. Spectacular colored discs light up and provide clear notes and sounds just by touching them. There are many levels of activity, from just touching and exploring through to a challenging 'Simon' game which needs concentration and memory.

Features:

- 8 interactive and passive activities with variations
- 16 different instrument and sound options
- Volume control
- Adjustable times for completion of games and difficulty levels
- Responsive to fingertip touch and robust, energetic use.
- No lamps to replace (ever) it uses LED technology
- Adjustable background light level
- Install anywhere
- Available as a standard panel and a long panel (see bottom left) which can be fixed at any height, for use while laying, sitting or standing

Code	Product
2353-012	Touch, Sound and Light Panel–upright version
2353-020	Touch, Sound and Light Panel–horizontal version



All Things Tactile



An introduction to tactile experience

Tactile sensation is a fundamental part of your overall sensory experience. It acts as a media for exploration and enhances the understanding of the environment around you.

As you develop, you build up an internal language for textures, as you do with all your senses. You learn about safe and dangerous tactile experiences through contact with the materials around you. Heat can be a safe or dangerous sensation, and how do you learn about that, how do you understand what is pleasant and what will hurt? You do this by exploring and learning about the properties of materials within safe parameters.

Rough and smooth, soft and hard, warm and cold, angular and curved, embossed and impressed, rigid and flexible, fine and coarse, linear and meandering, regular and random, absorbent and reflective. You get the idea! These are all properties considered when creating a mural, as well as overall shape, size, color, safety of materials used, flow of movement, as you explore it.

Murals make a strong statement when you walk into a space. They are something you can physically engage with and will give you a much stronger personal connection to a building. Often used to offer original and distinctive 'wayfinders' and signposts throughout a building.

The murals are an art form, individually designed and made to suit your needs and space. If you are interested in Tactile Murals contact SensoryOne at 1 877 232 3320.

Here is a small selection of Murals created previously, a much larger selection can be viewed in the Gallery on our website:

www.sensoryone.com





All Things Tactile



Tactile Panel No. 1

Basic Panel. A beautifully designed, well manufactured, simple textured panel with 12 different tactile experiences securely fixed to the panel. Natural wood finish panel as standard, but can be made in other colors on request.

Size: 120 wide x 100 high x 2.5 cm thick (47" x 39" x 1" thick).
Designed to be fixed vertically or horizontally.

Code	Product
0571-011	Tactile Panel No. 1



Tactile Panel No. 5

'Loopies' Tactile Panel. As well as the wide range of textures, this panel includes a very strong visual tracking feature, the 'Loopies' activity. Post plastic balls into the holes at the top and watch them tumble, disappear and reappear before emerging in the tray at the bottom.

Includes a pack of 10 balls.

Size: 145 wide x 120 high x 18 cm thick (57" x 47" x 7" thick).

Code	Product
0571-015	Tactile Panel No. 5

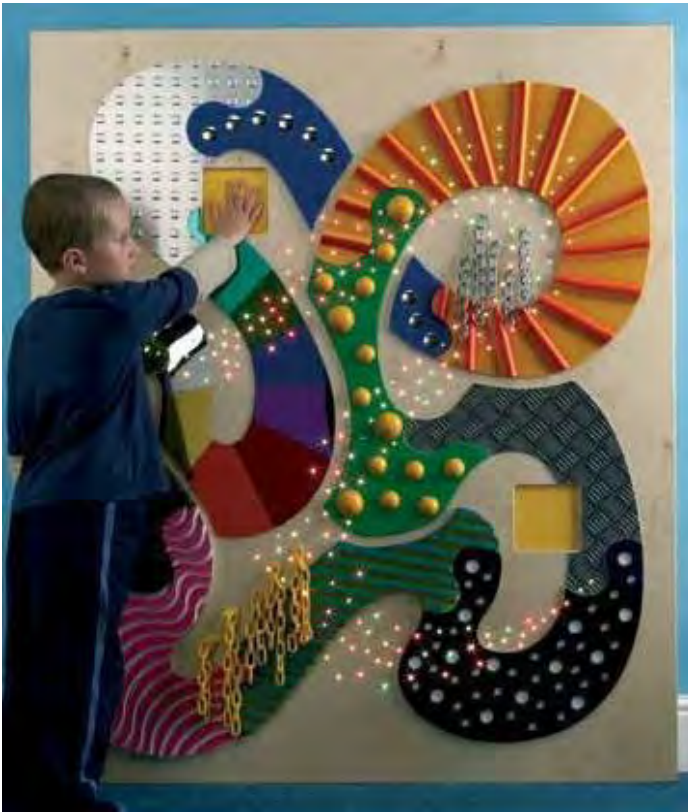

Tactile Panel No. 3

Fiber Optic Light Tactile Panel. Combines tactile and strong visual experiences by intermingling 200 points of brightly colored lights with the textures. The panel has integral switch plates that enable you to change the color of the lights and if used with a Nine Switch Keyboard, you can select and mix specific colors

Size: 120 wide x 100 high x 10 cm thick (47" x 39" x 4" thick).
Designed to be fixed vertically or horizontally.

Code	Product
0571-013	Tactile Panel No. 3

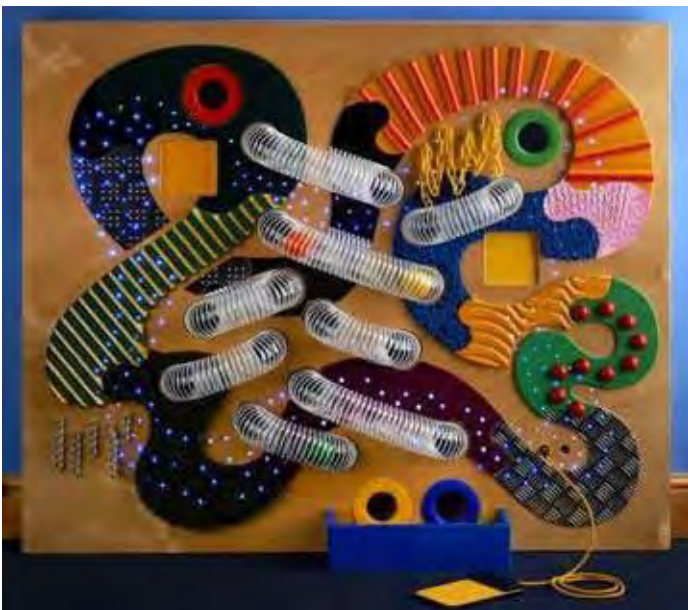

Tactile Panel No. 6

Fiber Optic Lights and 'Loopies' Tactile Panel.

This is a combination of panels No. 3, with Fiber Optic Lights and No. 5 with the 'Loopies' activity, making this a very exciting piece of equipment for people to explore and play with.

Includes a pack of 10 balls.

Size: 145 cm wide x 120 cm high x 18 cm thick (57" x 47" x 7" thick).

Code	Product
0571-016	Tactile Panel No. 6

Note: If you order two or more panels for the same site, we can and will vary the textures of each panel, but you must tell us when ordering.

All Things Tactile

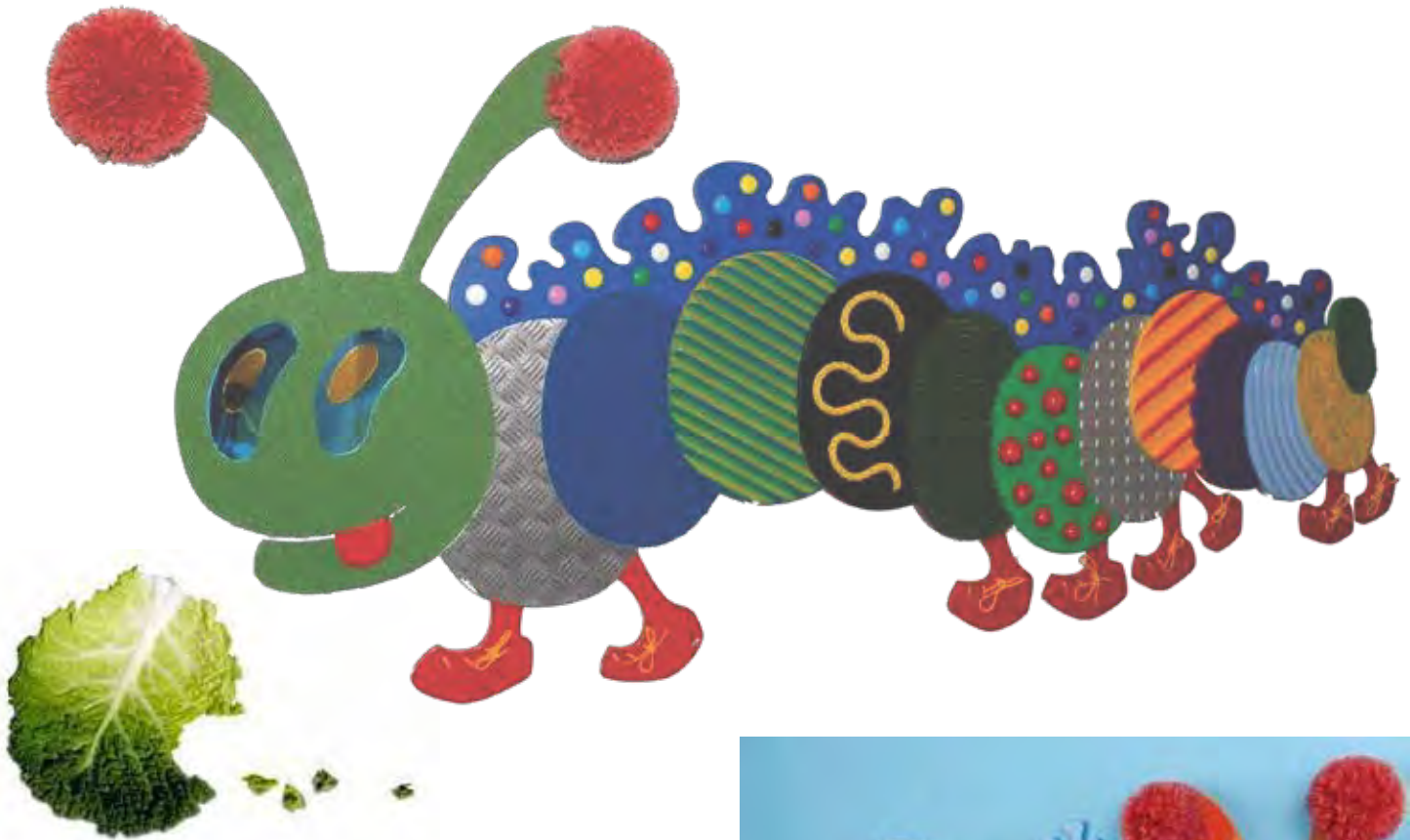

Very Tactile Caterpillar



This wonderful exploration of form and texture fits very well in public or open spaces within a building. Feel and trace the textures while discussing what the caterpillar could possibly eat to have such a varied skin. Consider the direction you want the caterpillar to face when ordering.

Sizes: Small 59" x 28" (150cm x 72cm) – Large 94" x 39" (238cm x 98cm)

Code	Product
1441-001	Very Tactile Caterpillar – Small – Right facing
1441-002	Very Tactile Caterpillar – Small – Left facing
1441-003	Very Tactile Caterpillar – Large – Right facing
1441-004	Very Tactile Caterpillar – Large – Left facing



Tactile Wall Tiles



Sometimes it is better to have tactile experiences spread out over a larger area, or just have a few to compare at one time. The Tactile Wall Tiles enable you to do both. The 16" x 16" (40cm x 40cm) squares have special fixings that enable them to be attached to any wall and be changed around from time to time. Designed to be robust, Tactile Wall Tiles offer good tactile contrast and look attractive; individually and in groups. There are no others that compare to them.



Code	Product
0725-101	Tactile Wall Tile – Fiber Mat/Orange Strips
0725-102	Tactile Wall Tile – Purple Fabric/Dimples
0725-103	Tactile Wall Tile – Waves/Silver Domes
0725-104	Tactile Wall Tile – Alloy/Purple Cord
0725-105	Tactile Wall Tile – Red Domes/Black Mat
0725-106	Tactile Wall Tile – Red Cushion/Grass
0725-107	Tactile Wall Tile – Soft Domes/Green Cord
0725-108	Tactile Wall Tile – Blue and Yellow Ribs/Orange
0725-109	Tactile Wall Tile – Color Domes/Brown Fiber
0725-110	Tactile Wall Tile – Yellow Chain/Silver Alloy
0725-111	Tactile Wall Tile – Blue Fiber/Wood Rings
0725-112	Tactile Wall Tile – Red Half Round/Blue Mat
0725-113	Tactile Wall Tile – Black Flock/Waves
0725-114	Tactile Wall Tile – Silver Chain/Orange Cushion
0725-115	Tactile Wall Tile – Yellow Rope/Mirror
0725-155	Set of 5 Tactile Wall Tiles (choose from the list of individual tiles).



0725-101



0725-102



0725-103



0725-104



0725-105



0725-106



0725-107



0725-108



0725-109



0725-110



0725-111



0725-112



0725-113



0725-114



0725-115



Infinity Hut – with Light Stars



To go into an Infinity Hut is a magical experience, which seems to defy the laws of space. Acrylic Mirrors on all four internal walls, featuring 250 points of changing colored lights shining through, offer the illusion of multiple reflections surrounded by an infinite galaxy of twinkling stars.

An integral Easy Switch Control enables you to change the color of the lights or switch them off, both achieved through large built-in switches or an additional plug in switch to suit your needs.

Remarkably, there is room inside for two adults or up to four children.

Equally impressive as part of a Soft Play Room or as a stand-alone unit within a Sensory Room, the Hut is specified with a cushioned roof to compliment the cushioned exterior walls when used in a Soft-Play room. All of our Infinity Huts support the weight of up to four adults.

For a Sensory Room, choose the Hut with a Projection Roof to enable you to project wonderful images and scenes to add another visual dimension to the experience. The projected image passes through the screen, reflects from the walls and creates wonderful stimulation and relaxation possibilities.

A truly awesome experience!

Exterior Size: 57 x 57" x 41" (145cm x 145cm x 105cm) high. Interior Size: Unknown!

Code	Product
0414-051	Infinity Hut – Light Stars with Soft Platform Roof
0414-052	Infinity Hut – Light Stars with Projection Roof
0414-053	Infinity Hut – Special Design

All Things Tactile

Tactile Floors



Create a floor of many different tactile areas to walk and move about on. Explore and experience with any part of your body. All of the 24 different interchangeable textures available are very carefully made to be comfortable to move about on, while having different tactile qualities. Each tile is 16" (40cm) square and nominally 1/2" (1.5cm) high. They are designed to be extremely robust, offer good tactile contrast and look attractive. No other tiles compare to them. All Tactile Floors include a 1/2" (1.5cm) high hardwood surround, tapered to ease access for wheelchairs and people with limited mobility.



Code	Product
0631-006	Tactile Floor 6 tiles – 52" x 36" (132cm x 92cm)
0631-009	Tactile Floor 9 tiles – 52" x 52" (132cm x 132cm)
0631-012	Tactile Floor 12 tiles – 68" x 52" (172cm x 132cm)
0631-016	Tactile Floor 16 tiles – 68" x 68" (172cm x 172cm)
0631-018	Tactile Floor 18 tiles – 99" x 52" (252cm x 132cm)
0631-020	Tactile Floor 20 tiles – 83" x 68" (212cm x 172cm)
0631-024	Tactile Floor 24 tiles – 99" x 68" (252cm x 172cm)
0631-099	Tactile Floor – Special size

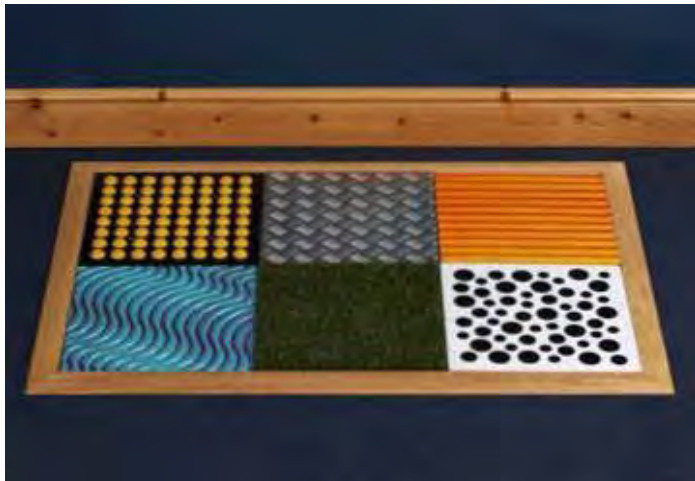



1925-001



1925-002



1925-003



1925-004



1925-005



1925-006



1925-007



1925-008



Tactile Splats/Puddles



We have included the 'Splats' in a number of Murals and they are so popular that we have decided to make them a standard product. Each 'Splat' is like a puddle on the wall, filled with an exciting and colorful texture.

They can be placed in random groups aligned along a wall or used as wayfinders around a building. Made with a wide range of materials, surrounded with painted plywood. They have two secure fixing plates for wall mounting. Size: Approx. 16" x 12" (40cm x 30cm) random shapes.

Code	Product
1925-001	Tactile Splat No.1 – Speckled Fabric
1925-002	Tactile Splat No.2 – Metal Stripes
1925-003	Tactile Splat No.3 – Green Domes
1925-004	Tactile Splat No.4 – Silver Domes
1925-005	Tactile Splat No.5 – Blue Fibres
1925-006	Tactile Splat No.6 – Red Stripes
1925-007	Tactile Splat No.7 – Yellow Cushion
1925-008	Tactile Splat No.8 – Grass
1925-081	Set of 8 Tactile Splats (one of each)

All Things Tactile



Wot's in the Wellie



An exciting and humorous activity panel with brightly colored wellies, securely fastened to a puddle shaped panel. Hide small objects in each wellie for children to explore, discover, match, count and talk about. It's fun just to explore the tactile properties of the wellies. As well as the two standard panels they can be included as part of larger Tactile Murals. Does not include the balls or other objects to put in the wellies.

Code	Product
1377-001	Wot's in the Wellie – Small 31" x 24" (80cm x 60cm) panel with 4 pairs of wellies
1377-002	Wot's in the Wellie – Large 45" x 30" (115cm x 75cm) panel with 7 pairs of wellies





Set 1

Tactile Discs

Two sets of wonderful textured discs in brightly colored synthetic rubber. They give opportunity for a wide range of activities involving whole body movement, comparison between what you feel with your feet and hands, describing the textures, comparing the colors, remembering the positions of the discs and other creative games. Each set consists of 5 large discs, 5 hand sized ones, a blindfold and a bag.

Code	Product
1515-117	Tactile Discs – Set 1
1515-118	Tactile Discs – Set 2
1515-116	Tactile Discs – Complete Set 1 and 2



Set 2



Set 1 and 2

Sensory Learning



Acrylic Mirrors



Optically correct reflected images are important in the success of a sensory room. Great care is taken when supplying and fitting these mirrors, 1/8" of acrylic mirror is adhered to a baseboard - making them virtually unbreakable and ensuring a good quality image.

Code	Product
0718-023	Backed Acrylic Mirror – 47" x 23" (120cm x 60cm)
0718-024	Backed Acrylic Mirror – 47" x 31" (120cm x 80cm)
0718-025	Backed Acrylic Mirror – 47" x 39" (120cm x 100cm)
0718-026	Backed Acrylic Mirror – 47" x 47" (120cm x 120cm)
0718-027	Backed Acrylic Mirror – 62" x 47" (160cm x 120cm)
0718-028	Backed Acrylic Mirror – 71" x 47" (180cm x 120cm)
0718-029	Backed Acrylic Mirror – 94" x 47" (240cm x 120cm)
0718-030	Backed Acrylic Mirror – made to any size



Distortion Mirror



It can be very exciting to explore the image of our own body and see it distort and change shape as you move around in front of a mirror. Made of acrylic mirror backed with plywood and framed. Size: 59" x 24" (151cm x 61cm)

Code	Product
0718-042	Distortion Mirror – 59" x 24" (151cm x 61cm)



Dome Mirrors

Dome Mirrors give a wide field of vision into all areas of a room, which gives interesting play opportunities when placed above a Ballpool or other equipment. It can also be reassuring when above a Waterbed or other cushioning, enabling people to have a view of everything happening around them.

Code	Product
0718-011	Large Dome Mirror – 37" (95cm)diameter
0718-012	Small Dome Mirror – 25" (65cm)diameter
0718-013	Demi-hemisphere Mirror – 31" (80cm)wide



Soft Frame Bubble Mirrors

Exciting multi-image mirrors which alter your reflection as you move around in front of them. A focal point for visual experience for people of all ages. The mirrors are surrounded with a 2" x 2" (5cm x 5cm) soft, wipe clean frame.

Dome Soft Frame Mirrors are 9 available with multi-color, blue and white frames.

3 Dome Soft Frame Mirrors are available with multi-color, red, yellow and white frames. Sizes: x 12" (84cm x 30cm) with 3 domes.

Mirror Frames and Color Windows



Mirror Frames and Color Windows encourage two-handed use and the exploration of reflection and the view of your surroundings in different colors. Supplied in red, yellow and blue, position them together and explore color mixing too.

The handles are made to give open handed grasp and if this is too challenging, place your hand in the space and 33" x 33" (84cm x 84cm) with 9 domes 33" maneuver the frame easily. Four holes enable you to suspend the frame at any angle to offer easy visual access.

Code	Product
0718-101	9 Dome Soft Frame Bubble Mirror Multi-colored surround
0718-102	9 Dome Soft Frame Bubble Mirror Blue surround
0718-103	9 Dome Soft Frame Bubble Mirror White surround
0718-106	3 Dome Soft Frame Bubble Mirror Multi-colored surround
0718-107	3 Dome Soft Frame Bubble Mirror Red surround
0718-108	3 Dome Soft Frame Bubble Mirror Yellow surround
0718-109	3 Dome Soft Frame Bubble Mirror White surround
0718-110	3 Dome Soft Frame Bubble Mirrors Set of 4

Code	Product
0718-301	Hand-held Mirror Frame
0718-303	Set of 3 Hand-held Color Windows



Sensory Learning

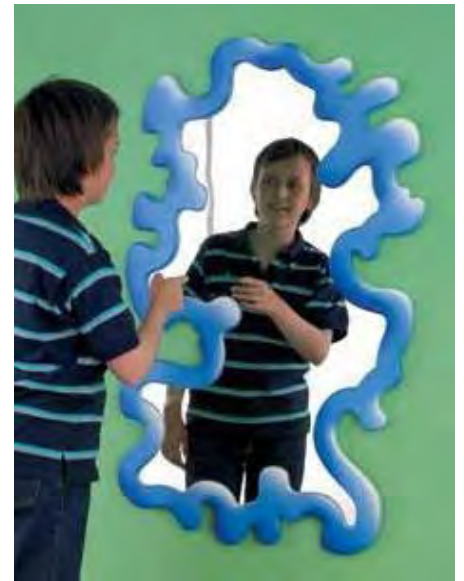

Puddle Mirrors



Safe, framed and backed acrylic mirrors with an element of fun and organic form. They brighten up any space and let you see your reflection in the 'puddle'. Framed versions give you a feeling of a three-dimensional watery form and the unframed versions rely on the mirror shape to form the puddle. They can be fixed horizontally or vertically. The mirror is adhered to a base panel and all edges are chamfered or rounded to make it extra safe.

Code	Product
0718-202	Medium Framed Puddle Mirror – 35" x 19" (88cm x 48cm)
0718-203	Large Framed Puddle Mirror – 43" x 27" (108cm x 68cm)
0718-206	Medium Unframed Puddle Mirror – 34" x 19" (88cm x 48cm)
0718-207	Large Unframed Puddle Mirror – 43" x 26" (108cm x 68cm)



Sensory Learning



Hilltops and River Stones

Challenging children's balance and coordination skills, River Stones and Hilltops feature rubber feet to prevent slipping. Position according to the nature of the session and the ability of the child or use to form an obstacle for buggies or wheelchairs. Hilltops, the taller of the two products; is best used by more physically ambitious children. River Stones size: 10" x 10" x 1 3/4" (25cm x 25cm x 4.5cm) and 14" x 14" x 3" (36cm x 35cm x 8.5cm) Hilltops size: 16.5" x 16.5" x 10" (42cm x 42cm x 25.5cm) (largest) Maximum load 110 lbs (50 kilos)

Code	Product
1515-120	River Stones (set of 6)
1515-121	Hilltops (set of 5)



The Mountain

A large mountain designed to challenge children to climb, balance and jump off. The four steps will test your level of ability and daring. It is fitted with non-slip rubber feet, but remember that some children will need a helping hand when tackling this challenge.

Size: 25.5" x 19" x 12.5" high (65cm x 49cm x 32cm).

Code	Product
1515-122	The Mountain



Musical Pads

Create musical notes by stepping, jumping, hitting or pressing on the soft discs. These 8 robust pads can be used indoors or outdoors to make learning musical notation fun!

Code	Product
1936-010	Musical Pads

Sensory Learning



16-peg Cogboard



Designed to be wall-mounted, the board is presented at an angle to give easy access for people sitting or in wheelchairs. The giant cogs can be interchanged to create new visual displays and encourage more sophisticated exploration. Two different handles are used to turn them.

Size: 44" x 28" (114cm x 71cm)

Code	Product
0125-001	16-peg Cogboard

Cogboards

Developed as a large and simple piece of equipment to encourage manipulative and motor skills, hand-eye coordination and the understanding of basic mechanical movement, while creating interesting moving coloured patterns.



Floor Cogboard



Nine patterned cogs and two handles fit onto the pegs in any order you wish. Designed to be used on the floor. Size: 39" x 20" (100cm x 50cm)

Code	Product
0125-002	Floor Cogboard



Helter-skelter Loopie



Used on a table or on the floor. The Helter-skelter Loopie encourages grasp, reaching up, release and then anticipation and waiting while you watch the ball twist and tumble its way down to the base, dropping out into the tray at the bottom.

Size: 30" x 20" x 12" (75cm x 50cm x 30cm)

Code	Product
0690-011	Helter-skelter Loopie



Double Helter-skelter Loopie



Similar to the single version, but with two entrance holes to post the balls into.

The balls trundle down the tubes in different directions and speeds, eventually dropping into the tray at the bottom.

The single sided version – has the entrance and exit holes on the same side.

The double sided version – the balls are posted on one side and exit on the opposite face, encouraging understanding of object permanence, social interaction, use of motor skills, etc.

Size: 30" x 18" x 15" (75cm x 46cm x 37cm)

Code	Product
0691-012	Double Helter-skelter Loopie (single sided)
0691-013	Double helter-skelter Loopie (double sided)



Two-Loopie Wall Panel



A wall mounted version. Simply fix to any wall at a height to suit the users. Two tubes twist and turn around each other, so that when you post the balls you have to anticipate which hole they will pop out of at the bottom. Place any container under the Loopie to catch the balls (container not supplied). Supplied with 10 balls.

Size: 42" x 18" x 8" (109cm x 47cm x 16cm)

Code	Product
0692-021	Two-Loopie Wall Panel



Four-Loopie Wall Panel



This is the giant Loopie, designed to encourage lots of gross motor movement, manipulation, anticipation, understanding object permanence, visual tracking, communication and all the basic skills we need to play and have fun. Four transparent tubes which zig-zag across and down, making the balls appear and disappear in unexpected places, eventually tumbling into the tray at the bottom. The panel can be fixed at floor level or any height against a flat wall.

Supplied with 20 Balls.

Size: 58" x 47" x 11" (148cm x 120cm x 20cm)

Code	Product
0693-031	Four-Loopie Wall Panel



Spare Balls for 'Loopies'



Creativity and innovation should be actively encouraged in any Sensory session; however, we recommend ONLY 'Loopie' balls are used.

Code	Product
0691-101	Pack of 10 Spare Loopie Balls
0691-102	Pack of 50 Spare Loopie Balls

Liquid Floor Tiles

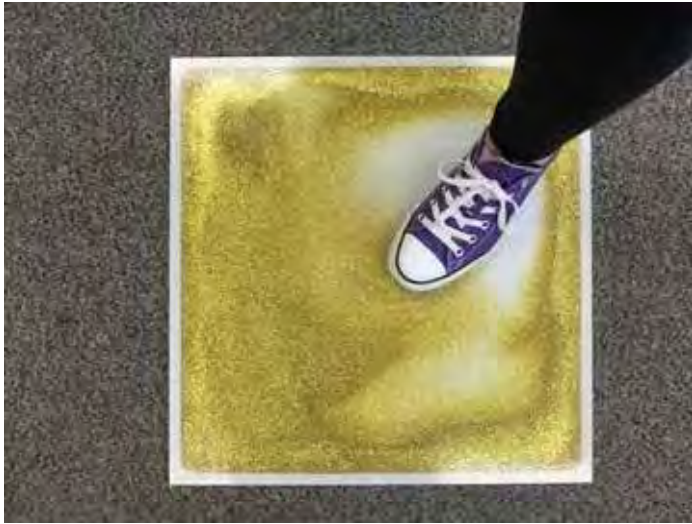

Gold Glitter Liquid Floor Tiles

Providing a wonderful visual and tactile experience, the golden glitter inside swirls and sparkles around as you move on the Tile. Designed to withstand any amount of jumping and strenuous use by children and adults as well as the added weight of a wheelchair. Liquid Floor Tiles can also be used on a table top or any flat surface and manipulated with your hands. A small amount of pressure creates a dramatic visual effect. Size: 20" x 20" x 1/4" thick (50cm x 50cm x 0.7cm thick)

Code	Product
1348-511	Gold Glitter Liquid Floor Tile
1348-514	Gold Glitter Liquid Floor Tiles – Set of 4

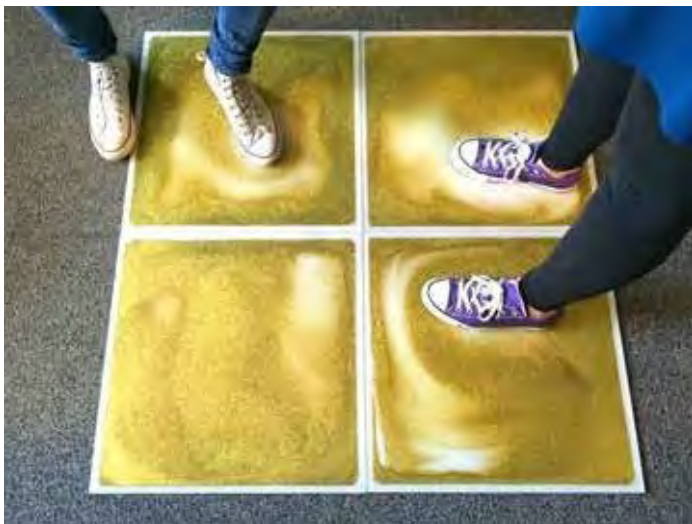

Small Liquid Floor Tiles

Ideal for smaller children, in small spaces or table top use. A wonderful visual and tactile experience, that really does encourage movement and exploration. Size: 12" x 12" x 1/4" thick (30cm x 30cm x 0.7cm thick)

Code	Product
1348-301	Liquid Floor Tile – 12" x 12" (30cm x 30cm) – Black/Turquoise
1348-302	Liquid Floor Tile – 12" x 12" (30cm x 30cm) – Yellow/Green
1348-303	Liquid Floor Tile – 12" x 12" (30cm x 30cm) – Blue/Blue
1348-304	Liquid Floor Tile – 12" x 12" (30cm x 30cm) – Pink/Purple
1348-305	Liquid Floor Tile – 12" x 12" (30cm x 30cm)– Orange/Red
1348-306	Liquid Floor Tile – 12" x 12" (30cm x 30cm)– Red/Blue
1348-309	Set of 6 Liquid Floor Tiles – 12" x 12" (30cm x 30cm)





Liquid Floor Tiles

A wonderful visual and tactile experience, that encourages movement and exploration of the surfaces. They are very thin floor tiles with flowing colors that swirl around as you move about on them. They will withstand any amount of jumping on and strenuous use by children and adults as well as the weight of wheelchairs and trolleys. Can also be used on a table top or any flat surface. It only needs a little pressure to create a dramatic visual effect.

Size: 20" x 20" x 1/4" thick (50cm x 50cm x 0.7cm thick)

Code	Product
1348-501	Liquid Floor Tile – 20" x 20" (50cmx50cm)– Black/Turquoise
1348-502	Liquid Floor Tile – 20" x 20" (50cmx50cm)– Yellow/Green
1348-503	Liquid Floor Tile – 20" x 20" (50cmx50cm)– Blue/Blue
1348-504	Liquid Floor Tile – 20" x 20" (50cmx50cm)– Pink/Purple
1348-505	Liquid Floor Tile – 20" x 20" (50cmx50cm)– Orange/Red
1348-506	Liquid Floor Tile – 20" x 20" (50cmx50cm)– Red/Blue
1348-509	Set of 6 Liquid Floor Tiles – 20" x 20" (50cm x 50cm)

Liquid Floor Discs

The same wonderful visual and tactile experience as the square tiles, Liquid Floor Discs are a magnificent addition to your armory of sensory equipment – use them to enrich literacy and numeracy sessions, simply add imagination! A motivating resource that encourages and rewards movement and exploration of the surfaces, Liquid Floor Discs are available for portable use or set in to the flooring of a permanent installation.

Size: 22" (50cm) diameter x 1/4" (0.6cm) thick.

Code	Product
1348-034	Liquid Floor Disc – 23" (60cm)diameter – Turquoise
1348-035	Liquid Floor Disc – 23" (60cm) diameter – Red
1348-036	Liquid Floor Disc – 23" (60cm)diameter – Yellow
1348-037	Liquid Floor Disc – 23" (60cm)diameter – Green
1348-038	Liquid Floor Disc – 23" (60cm)diameter – Black
1348-039	Liquid Floor Disc – 23" (60cm)diameter – Violet
1348-040	Set of 6 Liquid Floor Discs



Sensory Integration



Sensory Integration has become an essential tool for encouraging vestibular, tactile and proprioceptive development. It is a methodology used by many Occupational Therapists throughout the world.

The provision of equipment for this fits well with manufacturing and installation expertise.

Therefore, we are working with Southpaw Enterprises to provide a range of their original Sensory Integration Equipment. .

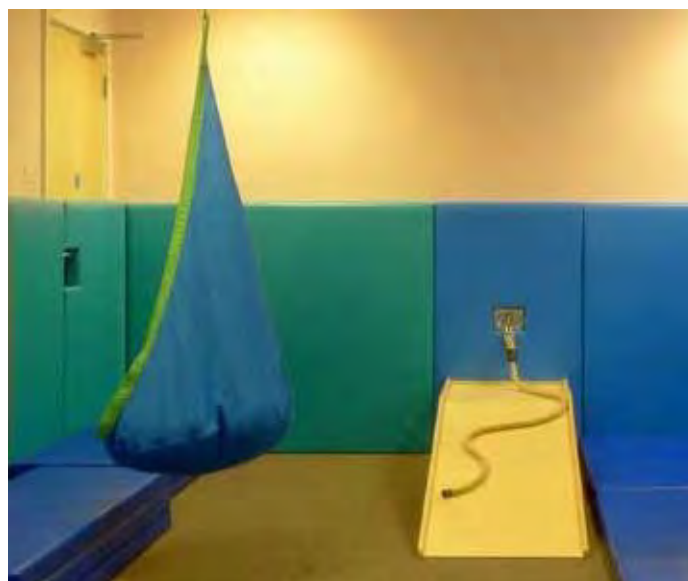

Southpaw Hanging System

Safety Snap – Provides a quick and secure way to connect hanging equipment. The selfclosing gate prevents it opening accidentally when under pressure. Working load: 992lb (450kg)

Safety Rotation Device – This enables rotating and circular movement as well as swinging and prevents ropes and equipment twisting when in use.

It is supplied with one Safety Snap, and a second one will be needed to connect the other end. Working load: 882lb (400kg)

Heavy Duty Safety Rotation Device – The components of the original Rotational Device have been enlarged to provide greater durability. The wear-point of the eyebolt is 70% greater, which will extend the useful life of the Rotation Device. Working load: 992lb (450kg)

Rope with Eye Splice – Extremely strong rope with a smooth woven outer cover and a steel lined loop at one end, for attachment to the hanging system or equipment.

Height Adjuster with Safety Snap – This enables quick and easy height adjustment to hanging equipment. The quick release cam mechanism slides up and down the rope and the equipment attaches to the adjuster.

Suspension and Height Adjustment Kit

The kit includes a Safety Snap, Rotational Device, 10ft (3m) of Therapy Rope with Eye Splice, and a Height Adjuster with Safety Snap. These items may also be purchased separately.

Vertical Stimulation Device

The Vertical Stimulation Device provides excellent vestibular and proprioceptive stimulation because it allows controlled bouncing and vertical movement.

It comes complete with two locking safety snaps and four industrial quality elastic loops; two single loops, each with a working load of 30lbs (13.5kg), and two double loops, which have a working load of 59lbs (27kg) per double loop.

This setup provides a working load range of 29 to 181lbs (13.5 to 82kg). You can add additional double loops in place of the single loops to increase your Vertical Stimulation Device's capacity to 240lbs (109kg).

Code	Product
2057-101	Southpaw Safety Snap
2057-102	Southpaw Safety Rotation Device
2057-108	Southpaw Heavy Duty Safety Rotation Device
2057-103	Southpaw Rope with Eye Splice – 10ft (3m)
2057-106	Southpaw Rope with Eye Splice – 20ft (6m)
2057-107	Southpaw Height Adjuster with Safety Snap
2057-109	Southpaw Suspension and Height Adjustment Kit
2057-110	Vertical Stimulation Device





Cuddle Swings

Increase calming and organize input by providing deep touch pressure and vestibular stimulation in our Cuddle Swings. Postural flexion is also encouraged while your child or client lies in the swing. Children will find this soft, stretchy swing fun and comfortable. Does not include Safety Snap. Suitable for children. Size: 39.5" x 39.5" (101cm x 101cm). Working load: 198lb (90kg)

Adult Cuddle Swing: A larger swing that is suitable for adults. Working load: 298lb (135kg)

Code	Product
2057-141	Southpaw Cuddle Swing
2057-142	Southpaw Adult Cuddle Swing

Linear Glides

Linear Glides are ideally used for vestibular input, increased balance, address weight shifting abilities and increase bilateral coordination. The platform has cushioned edges and a removable carpet and the kit includes pull handles and safety snaps. They work best when hung from two points (see details below).

Standard Linear Glide

Size: 45x24x59" high (115x60x150) Working load: 247lb (112kg).

Two fixing points between 43" (110cm) and 53" (135cm) apart.

Adult Linear Glide

Size: 59x29x70" high (150x74x178cm) Working load: 247lb (112kg)

Two fixing points between 49" (125cm) and 60" (155cm) apart.

Linear Glide Tent Cover

The Linear Glider Tent Cover works with the Adult Linear Glider to provide a small space for people who may become over-stimulated. It provides the ability for a therapist and child, or two peers, to work on activities at the same time. This simple addition provides a great way to improve attention, focus and one-on-one interaction.

Code	Product
2057-137	Southpaw Standard Linear Glide
2057-138	Southpaw Adult Linear Glide
2057-139	Southpaw Adult Linear Glide Tent Cover



Platform Swings

Platform Swing: The swing enables you to create a wide range of tilting movements. The four control lines can be unsnapped from the main suspension line to vary the grade of movement. The platform has a 30" (77cm) square timber base with padded edges and removable nylon carpet.

Size: 30.5x30.5x 59" high (78x78x150cm) Working load: 298lb (135kg)

Advantage Platform Swing: This is a more economic and basic version of the platform swing, without the tilt adjustment. Size: 30.5x30.5x 59" high (78x78x150cm) Working load: 298lb (135kg)

Code	Product
2057-131	Southpaw Platform Swing
2057-132	Southpaw 'Advantage' Platform Swing



Sensory Integration



Flexion T-Bar

A great way to address balance and bilateral strength, and also provide vestibular input for more physically involved people. The Southpaw Flexion T-Bar challenges your clients' flexion patterns as they enjoy activities. Advanced users will be stimulated when they hang beneath the T-Bar and shift from side to side while swinging. Use for a wide range of rotational and orbital movements. Includes a Control Strap and one Safety Snap.

Code	Product
2057-164	Southpaw Flexion T-Bar



Frog Swing

The Frog Swing is one of the most popular swings for providing proprioceptive stimulation and vertical movement in a domestic or clinical setting. The Frog Swing has a wood crossbeam that allows it to be adapted for a working load of 150lb (68kg). The Frog Swing comes with three single vertical stimulation loops for an initial working load of up to 88lb (40kg). These loops can be removed to provide a greater bounce for younger clients. You can easily increase the working load to 120lb (54kg) or even 150lb (68kg) by simply adding more loops.

Code	Product
2057-421	Southpaw Frog Swing

Bolster Swings

Bolster Swing: It can be used for many activities including laying on, hanging underneath, sitting and balancing on, as well as having someone with you for support. The wooden crossbar can be detached and used as trapeze bar or to support a therapy net. The Bolster Swing is heavily padded and covered in soft vinyl fabric. Size: 67.5" high x 47" long x 9" diameter (172 cm x 120cm x 23cm) Working load: 330lb (150kg) **Pony Bolster Swing:** It is smaller and lighter than the standard swing and is good for working with smaller children and in more confined spaces. Size: 69" high x 35" long x 9" diameter. (175cm x 90cm x 23cm) Working load: 330lb (150kg).

Code	Product
2057-111	Southpaw Bolster Swing
2057-112	Southpaw Pony Bolster Swing



Sling Swings

Southpaw's Sling Swing, a single-point suspended hammock that provides full and even support. Made of soft nylon knit fabric, the Sling Swing works like a net but without any tangle problems. Supported with heavy-duty vinyl for strength and durability, the Sling Swing offers responsive support, and provides all support in a flexion position. It also offers vestibular stimulation prone or seated. Includes Safety Snap.

Child Sling Swing: Size: 59" (150cm) high. Working load: 165lb (75kg) **Adult Sling Swing:** Size: 59" (150cm) high. Working load: 330lb (150kg)

Code	Product
2057-125	Southpaw Child Sling Swing
2057-126	Southpaw Adult Sling Swing

Therapy Net and Adaption Kit

Therapy Net: Southpaw's Therapy Net is cut on the bias, so that it stretches without pinching fingers. It is suitable for children and adults to use. Size: 47" (120cm) high. Working load: 198lb (90kg)

Net Adaption Kit: The kit includes a padded wooden insert seat and top spreader bar which makes the therapy net more comfortable, less confining and easier to get in and out of.

Code	Product
2057-121	Southpaw Therapy Net
2057-122	Southpaw Net Adaption Kit

Southpaw Tube Swing Kit

The Tube Swing is great fun. Its natural bounce and movement is great for proprioceptive and vestibular stimulation. The tube can be inflated to different sizes. It is best fitted with a Safety Rotational Device and Safety Snap (not provided in the set). Size: 37.5" (95cm) diameter. Working load: 247lb (112kg) Supplied with Harness and Heavy Duty Tube.

Code	Product
2057-151	Southpaw Tube Swing Kit
2057-152	Southpaw Tube Swing Harness only
2057-153	Southpaw Heavy Duty Tube only



Sensory Integration



Large Bounce Disc

Bounce is created by 8 springs, offering a clever alternative to conventional trampolines with added stability, helping to build confidence. The base is made of Baltic Birch.

Code	Product
2057-341	Southpaw Large Bounce Disc



Acrobat Swing

Southpaw's Acrobat Swing can be hung from two, three or four attachment points. As a hammock, it provides vestibular input with increased pressure offering a calming effect. The three or four-point hookup increases the challenge by allowing clients to climb through the layers. Or, it can provide a calming tent-like space. This swing is great for developing body awareness and addressing motor planning skills. Made of four layers of heavy-duty, four-way stretch Lycra, this swing provides varying degrees of resistance, layer by layer. Working load: 298lb (135kg)

Code	Product
2057-425	Southpaw Acrobat Swing – Silver
2057-426	Southpaw Acrobat Swing – Rainbow Colors

Flexion Disc Swing

This swing gives opportunity for a wide range of movement, from gentle pushing and rocking to a more active shaking, rotating and orbiting. It includes a control strap that can be attached to the top or bottom of the swing.

Heavily padded center column and edges, and featuring a carpet on the base, it must be hung from a minimum ceiling height of 8ft (240cm).

Size: 24" (61cm) diameter x 35" (90cm) high. Working load: 298lb (135kg)

Code	Product
2057-161	Southpaw Flexion Disc Swing – 24" (61cm) dia.
2057-163	Southpaw Large Flexion Disc Board – 32" (80cm) dia.

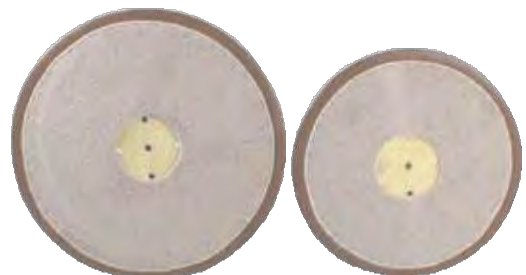



Resistance Tunnels

Challenge your clients with heavy work while developing body awareness and motor planning using Southpaw's Resistance Tunnel. As your client pushes a therapy ball or other large object through the tunnel, he/she will experience varying degrees of resistance as well as tactile and deep touch input. Made from a ribbed knit cotton, Lycra spandex and nylon jersey. There are three convenient reinforced handles attached for you to hold and pull while your client pushes through the tunnel. Colors may vary.

Code	Product
2057-321	Southpaw Resistance Tunnel – 118" (300cm) long
2057-322	Southpaw Resistance Tunnel – 177" (450cm) long



Moon Swing

The Moon Swing is a great means for addressing bilateral coordination, balance, strength and vestibular input. Its size and shape allows the therapist to create an easy mount and dismount for the user. The soft gooseneck is extra long to help the user hang on. Exceptionally durable, with a ring connection point that is reinforced for extended wear, the Moon Swing comes with two inserts for different motor planning possibilities. One insert is soft, fine bi-foam material that gives the user a swing with a changing consistency, and requires more difficult flexion patterns. The firmer insert allows the user to stand, kneel or do complicated riding activities.

Size: 48" x 17.5" diameter (122cm x 45cm). Working load: 198lb (90kg)

Code	Product
2057-422	Southpaw Moon Swing

Trapeze Bars

The Southpaw Trapeze Bar allows clients to work on their upper extremity strength, increase their flexion posture, and improve their motor planning skills. It offers a fun way to challenge many of their overall development skills. Safety Snaps included. Working load: 198lb (90kg).

Code	Product
2057-401	Southpaw Child Trapeze Bar
2057-402	Southpaw Adult Trapeze Bar



Sensory Integration



Belly Bumper

The Belly Bumper is great for both upper and lower body strengthening for your small clients. Kneel and push the roll forward and back to strengthen arms and shoulders. Or, sit on the floor, place his/her feet on the roller, and push back and forth to help increase thigh and calf strength. A strong PVC core is covered in foam and vinyl and then attached to two wooden panels by plastic star knobs.

Code	Product
2057-335	Southpaw Belly Bumper



Advantage Scooter Board

No developmental therapy program is complete without a Scooter Board. Use it for obstacle courses, games and races to help boost posture and coordination skills. Tow strap included.

Code	Product
2057-338	Southpaw Advantage Scooter Board



Bolster Scooter

The Bolster Scooters are a great tool for working with your clients on extension patterns as well as bilateral motor coordination. Sitting astride a movable surface aids development of balance reactions. Add a little fun to your therapy sessions, and let your clients position in prone, as they see how fast they can go using their arms and feet to propel themselves across the room. Or they can sit upright, hold on to the wooden handle, and practice walking. Both scooters have a Baltic Birch base mounted on four freely rotating castors. A sturdy foam half-barrel sits on top of the base and is covered in phthalate-free and lead-free vinyl. Colors may vary.

Code	Product
2057-336	Southpaw Bolster Scooter – Small
2057-337	Southpaw Bolster Scooter – Large



Steamroller Delux

Some children crave deep pressure and will love the challenge of crawling between the rollers and being 'flattened' by the Steamroller. This piece of equipment offers more than just deep pressure. It allows children to work on motor planning skills, body awareness and shoulder stability as they work their bodies out of the device. It's a great addition to all of your therapeutic activities. The Steamroller can accommodate a small child up to an average-sized adult. The pressure can be changed by adjusting the tension bands. Comes with two sets of bands for this purpose. Colors may vary.

Code	Product
2057-311	Southpaw Steamroller Delux
2057-319	Replacement Bands for Steamrollers



The Top

Sometimes the simplest things are the best! The Top can be used for as many things as you can imagine, amongst them, rocking in, spinning, building a den, use as a boat (with very strict supervision) as a bin for target practice, for sensory integration work, etc. etc. It's made of strong plastic and has raised edges to prevent children getting their fingers caught or hurting themselves. Size: 31" (80cm) diameter x 17" (44cm) deep.

Code	Product
1515-101	The Top

Advantage Steamroller

This is an alternative Steamroller for younger children. It has one set of rollers to crawl through, but is very effective for deep pressure input. Colors may vary.

Note: Adult Supervision is recommended.

Code	Product
2057-312	Southpaw Advantage Steamroller
2057-319	Replacement Bands for Steamrollers



Balancing Board

For rocking from side to side, spinning around and balancing. It can be sat on, laid in or stood on and has hand bars to help with your stability. Suitable for indoor and outdoor use. Size: 30" (75cm) diameter x 7" (18cm) high. Maximum load 132lb (60kg)

Code	Product
1515-102	Balancing Board

Cushions and Supports



Bean loungers and cushions



Made with a very special fabric, in a wide range of colors!

We now have a range of bean cushions, to compliment the foam filled cushions, supports and soft shapes, used in Sensory and Soft Play rooms.

They are made with a soft textured, extremely durable polyurethane coated fabric, that feels wonderful to touch and is waterproof, breathable, anti-microbial, anti-fungal, phthalate free and fire retardant. All cushions have a fire retardant calico inner bag to contain the beads, so the outer cover can be taken off and cleaned, without spilling the beans.

The bean cushions are wonderful islands to sit on for storytelling and focused work. The larger ones can be molded to suit almost any posture and are good for small children to clamber over, or bigger people just sit or lay in. They can be thrown or stacked in a corner when not in use.



Giant Bean Disc



State your color choice when ordering: (See page 191) – Aqua, Berry, Black, Brown, Lime, Orange, Pink, Red, Royal, White, Yellow.

Code	Product
1518-511	Giant Bean Disc – 47" (120cm) diameter x 9" (24cm) thick

Large Bean Disc



State your color choice when ordering: (See page 191) – Aqua, Berry, Black, Brown, Lime, Orange, Pink, Red, Royal, White, Yellow.

Code	Product
1518-411	Large Bean Disc – 32" (80cm) diameter x 9" (24cm) thick



Medium Bean Disc



State your color choice when ordering: (See page 191) – Aqua, Berry, Black, Brown, Lime, Orange, Pink, Red, Royal, White, Yellow.

Code	Product
1518-311	Medium Bean Disc – 20" diameter x 9" thick (50cm x 24cm)

Polystyrene Beads

To refill the bean cushions.

1 cubic foot just tops up a cushion.

4 cubic feet fills a medium to large sized cushion.

10 cubic feet fills a large to giant sized cushion.

Code	Product
1518-001	Polystyrene Beads – 1 cubic foot bag
1518-004	Polystyrene Beads – 4 cubic feet bag
1518-010	Polystyrene Beads – 10 cubic feet bag



Large Bean Slab



State your color choice when ordering: (See page 191) – Aqua, Berry, Black, Brown, Lime, Orange, Pink, Red, Royal, White, Yellow.

Code	Product
1518-211	Large Bean Slab – 71" x 47" x approx. 5" thick (180cm x 120cm x 12cm)



Medium Bean Slab



State your color choice when ordering: (See page 191) – Aqua, Berry, Black, Brown, Lime, Orange, Pink, Red, Royal, White, Yellow.

Code	Product
1518-411	Medium Bean Slab – 47" x 35" x approx. 4" thick (120cm x 90cm x 10cm)

Cushions and Supports



Mini B Children's Bean Cushions

Large enough for children of all ages to lounge on. A range of 11 wonderful colors. Made with heavy duty wipe clean polyurethane fabric. Size: 29" high x 29" wide x 28" deep. (74cm x 75cm x 71cm) Weight: 6.5lb (3kg)

Code	Product
2556-101	Mini B Children's Bean Cushion – Aqua
2556-102	Mini B Children's Bean Cushion – Berry
2556-103	Mini B Children's Bean Cushion – Black
2556-104	Mini B Children's Bean Cushion – Brown
2556-105	Mini B Children's Bean Cushion – Lime
2556-106	Mini B Children's Bean Cushion – Orange
2556-107	Mini B Children's Bean Cushion – Pink
2556-108	Mini B Children's Bean Cushion – Red
2556-109	Mini B Children's Bean Cushion – Royal
2556-110	Mini B Children's Bean Cushion – White
2556-111	Mini B Children's Bean Cushion – Yellow



Mighty B Outdoor Bean Cushions

Wonderfully colorful, extremely tough outdoor Bean Cushions. Large enough for older children and adults to lounge on. **Extremely bright colors.** A range of 10 colors **Extremely tough fabric.** Made with heavy duty water-resistant polyester fabric. **Extremely well made in the UK.** All hems are double stitched and they have double zips to prevent accidental spillage of beans and inquisitive fingers. **Extremely durable.** Designed for outdoor use. **Extremely comfortable.** Molds to the shape of your body. See Swatch 3 for fabric colors.

Size: 37" high x 39" wide x 31" deep. (94cm x 99cm x 80cm) Weight: 11lb (5kg)

Code	Product
2556-201	Mighty B Outdoor Bean Cushion – Aqua
2556-202	Mighty B Outdoor Bean Cushion – Berry
2556-203	Mighty B Outdoor Bean Cushion – Black
2556-204	Mighty B Outdoor Bean Cushion – Brown
2556-205	Mighty B Outdoor Bean Cushion – Lime
2556-206	Mighty B Outdoor Bean Cushion – Orange
2556-207	Mighty B Outdoor Bean Cushion – Pink
2556-208	Mighty B Outdoor Bean Cushion – Red
2556-209	Mighty B Outdoor Bean Cushion – Royal
2556-210	Mighty B Outdoor Bean Cushion – White





Monster B Outdoor Bean Cushions

Made to the same exacting standard as the Mighty B Bean Cushions, but large enough for two adults to sit on together. Can be pushed into shape to support any adult. Size: 46" wide x 37" high x 31" deep (116cm x 94cm x 80cm) Weight: 14lb (6.5kg).

Code	Product
2556-301	Monster B Outdoor Bean Cushion – Aqua
2556-302	Monster B Outdoor Bean Cushion – Berry
2556-303	Monster B Outdoor Bean Cushion – Black
2556-304	Monster B Outdoor Bean Cushion – Brown
2556-305	Monster B Outdoor Bean Cushion – Lime
2556-306	Monster B Outdoor Bean Cushion – Orange
2556-307	Monster B Outdoor Bean Cushion – Pink
2556-308	Monster B Outdoor Bean Cushion – Red
2556-309	Monster B Outdoor Bean Cushion – Royal
2556-310	Monster B Outdoor Bean Cushion – White

Mighty B Real Fleece Bean Cushions

The ultimate in comfort and luxury
 Large enough for older children and adults to lounge on. A range of 4 natural colors. Made with heavy duty sponge clean fleece. All hems are double stitched and they have double zips to prevent accidental spillage of beans and inquisitive fingers. Size: 46" wide x 37" high x 31" deep (99cm x 94cm x 80cm)

Code	Product
2556-401	Mighty B Real Fleece Bean Cushion – Black
2556-402	Mighty B Real Fleece Bean Cushion – Brown
2556-403	Mighty B Real Fleece Bean Cushion – Cream
2556-404	Mighty B Real Fleece Bean Cushion – Grey



Cushions and Supports



Bubble Tube Bean Cushion



The Bean Cushion is an alternative to a foam cushion. The difference is that you can adjust and mold the Bean Cushion to the shape of your body posture and really snuggle into it. You can use it anywhere and use the cut-out area as an alternative means of support. See Fabric Swatch 1 on page 191 for colors.

Code	Product
0733-208	Bubble Tube Bean Cushion 57" x 57" x 7" (145cm x 145cm x 18cm) (approximately)
0733-210	Bubble Tube Bean Cushion – special size



Bubble Tube Cushions

No more cumbersome platforms, just a double-sided cushion which fits snugly around the Easy Access Bubble Tube base. It can be removed for wheelchair or portable hoist access, or simply to allow someone to stand up close to the Bubble Tube. Put it back in place to sit or lay on immediately adjacent to the tube. Double-sided also means a choice of colors to work with. See Fabric Swatch 1 on page 191 for colors.

Code	Product
0733-201	Bubble Tube Surround Cushion 39" x 39" x 6" (100cm x 100cm x 15cm)
0733-202	Bubble Tube Surround Cushion 47" x 47" x 6" (120cm x 120cm x 15cm)
0733-203	Bubble Tube Surround Cushion 57" x 57" x 6" (145cm x 145cm x 15cm)
0733-205	Half round Bubble Tube Surround Cushion 57" x 39" x 6" (145cm x 100cm x 15cm)
0733-209	Bubble Tube Surround Cushion Made to any size



Floor and Wall Cushions

We have a wide range of Cushions to cover walls, floors, pillars and other obstacles that need to be made safe for your Sensory Integration sessions.

Go to the Soft Play section (Page 182) to review some of the options available. Every item we supply is custom made to fit your individual space, so talk to us about your specific needs. Please call the team at 1 877 232 3320.

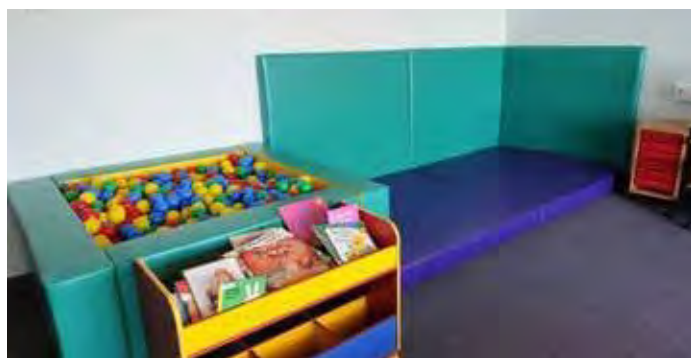



Folding Floor Cushions



Manufactured to exacting standards, these Folding Floor Cushions are a simple yet important development in the creation of successful Sensory Rooms. Use them as mattresses to lie on, fold them to create bench seats or to facilitate easy access to room features. Particularly comfortable when used in tandem with Back Support Cushions, the Folding Floor Cushions are made to suit your space and the needs of users. Available in 4" (10cm) or 6" (15cm) depths, Standard colors are Dark Blue and Cream (double sided) but there is a choice of 23 colors. See Fabric Swatch 1 on page 191 for colors. See Soft Play section on Page 182 for details of Standard Cushions.



Code	Product
0414-151	Folding Floor Cushion 39" x 47" x 4" (100cm x 120cm x 10cm) (39" x 16" x 12" (100cm x 40cm x 30cm) folded)
0414-152	Folding Floor Cushion 57" x 53" x 4" (145cm x 135cm x 10cm) (57" x 18" x 12" (145cm x 45cm x 30cm) folded)
0414-153	Folding Floor Cushion 86" x 53" x 4" (218cm x 135cm x 10cm) (86" x 18" x 12" (218cm x 45cm x 30cm) folded)
0414-159	Folding Floor Cushion 4" (10cm) thick – any other size
0414-161	Folding Floor Cushion 39" x 59" x 6" (100cm x 150cm x 15cm) (39" x 19.5" x 18" (100cm x 50cm x 45cm) folded)
0414-162	Folding Floor Cushion 57" x 59" x 6" (145cm x 150cm x 15cm) (57" x 19.5" x 18" (145cm x 50cm x 45cm) folded)
0414-163	Folding Floor Cushion 86" x 59" x 6" (218cm x 150cm x 15cm) (86" x 19.5" x 18" (218cm x 50cm x 45cm) folded)
0414-169	Folding Floor Cushion 6" (15cm) thick – any other size

Back Support Cushions



The Back Support Cushions are a great alternative to Wall Cushions in Sensory Rooms and Studios. They are designed to give lumbar support and shift your center of gravity, as well as a comfortable sitting posture when used with Floor Cushions. They are made to order and can be made in various widths and heights.

Code	Product
0414-142	Back Support Cushion – 39" wide x 31" high (100cm x 78cm)
0414-143	Back Support Cushion – 57" wide x 31" high (145cm x 78cm)
0414-144	Back Support Cushion – 86" wide x 64" high (218cm x 78cm)
0414-149	Back Support Cushion – any other size

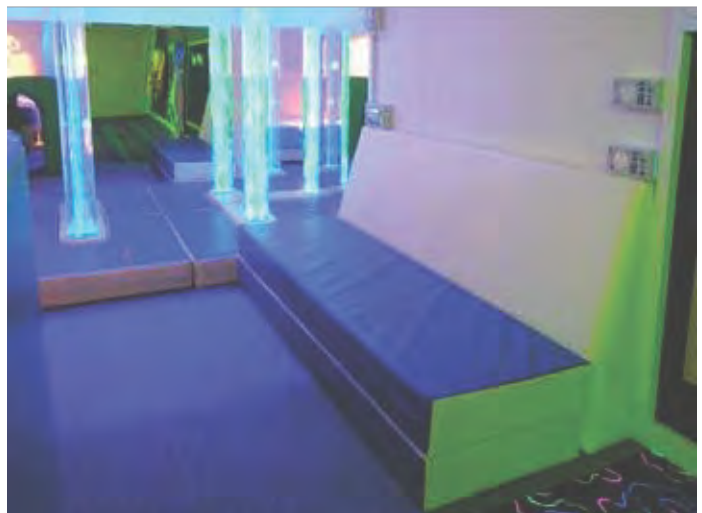

Soft Play



The best Soft Play rooms and equipment available!

Fun should be at the heart of any use of the Soft Play room but the potential benefits are wide ranging. To fulfil your objectives, whether providing space for boisterous play, developing motor skills or for specific teaching and relaxation requirements, sensitive and considered design is essential.

SensoryOne will design a space to reflect your individual needs and offers a huge range of pioneering features and equipment to enhance and compliment your finished environment.

This can include Projectors, Musical Steps, Activity Panels, Infinity Huts, Sound Systems or even 'Intelligent' Lighting.

To discuss your project, whether you'd like to refresh an existing space or create a new one, please contact us at 1 877 232 3320 or email customerservice@sensoryone.com.

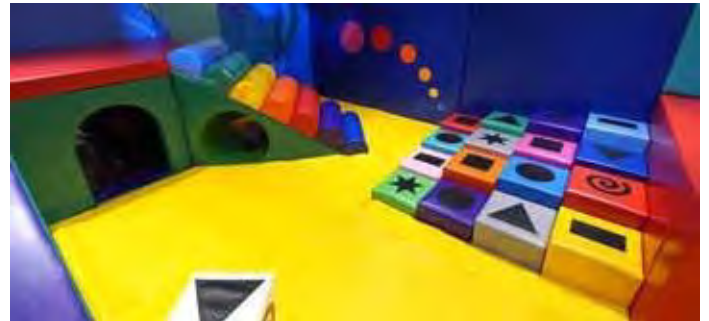

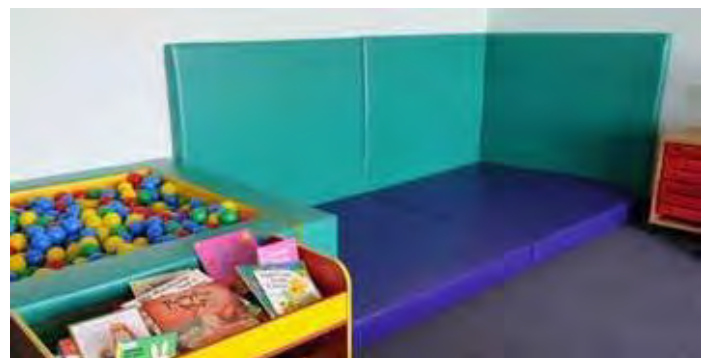

Soft Play

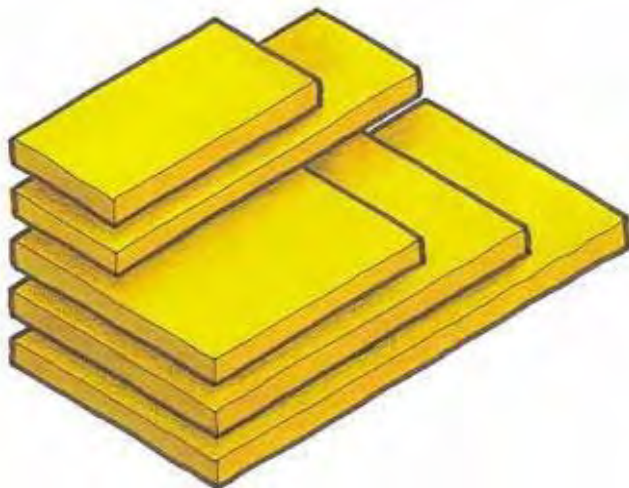

Floor Cushions

Floor Cushions are made to fit around and fill all the floor space between specific structures. The structures and Floor Cushions are made to a basic module enabling you to interchange pieces and alter the configuration of your Soft Play Room. All Floor Cushions are 6" (15cm) thick for extra safety and durability. (Be aware of the cushion thickness when comparing prices). Here are some standard sizes, but they can be made to any size that you want.

Code	Product
0414-012	Half Floor Cushion – 57" x 28.5" (145cm x 72.5cm)
0414-013	Three-quarter Floor Cushion – 57" x 43" (145cm x 109cm)
0414-014	Full Floor Cushion – 57" x 57" (145cm x 145cm)
0414-015	One-and-a-half Floor Cushion – 86" x 57" (217.5cm x 145cm)
0414-016	Double Floor Cushion – 114" x 57" (290cm x 145cm)
0414-019	Made to any size

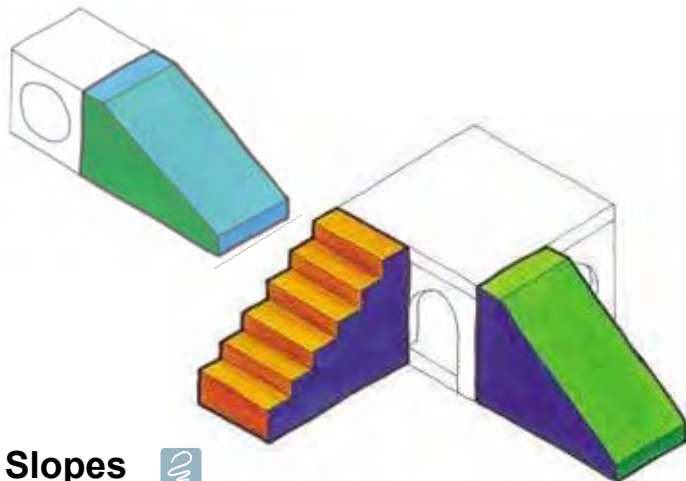

Slopes

Slopes of different heights can be used for clambering up and sliding down onto Floor Cushioning or into Ball Pool areas. Size 57 x 29 x 41" high (145 x 73 x 75cm) (or made to any size).

Code	Product
0414-023	Low Slope – 57" x 29" x 30" high (145cm x 73cm x 75cm)
0414-024	High Slope – 57" x 29" x 41" high (145cm x 73cm x 105cm)

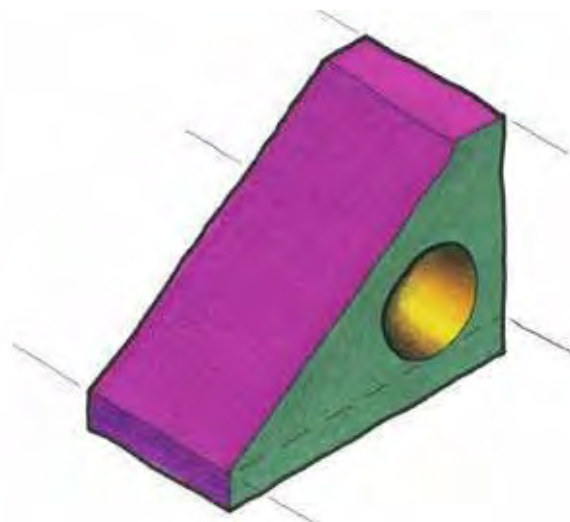

High Slope with Tunnel

You can slide down it, crawl through it and clamber up it. It's an essential part of any soft space featuring a hut structure. (Page 187).

Code	Product
0414-025	High Slope with Tunnel – 57" x 29" x 41" (145cm x 73cm x 105cm)

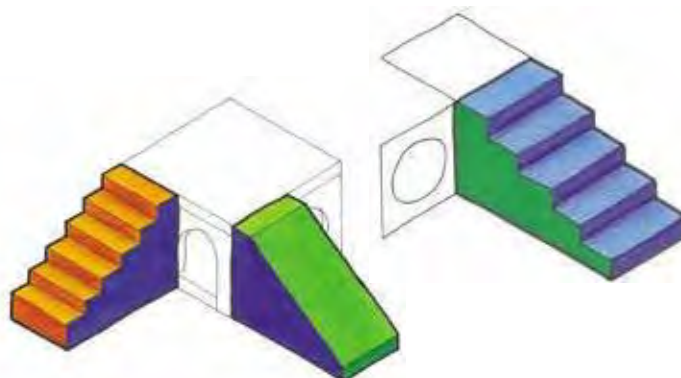

Steps

All our Steps are made to an exacting standard, with the fabric anchored firmly in place, to avoid slipping or baggy covers. **Low Steps** – For access to low structures such as Ball Pools, Tunnels and Balance Beams.

High Steps – For access to high level structures such as the Hut and Platforms.

Musical Steps – High steps with 6 pressure sensitive switches added, to give a range of sounds, rising in pitch as you go up the steps. Choose from a wide range of instruments and sounds. Includes volume control and a speaker too.

Code	Product
0414-021	Low Steps – 57" x 29" x 30" high (145cm x 73cm x 75cm)
0414-022	High Steps – 57" x 29" x 41" high (145cm x 73cm x 105cm)
0414-123	Musical Steps – 57" x 29" x 41" high (145cm x 73cm x 105cm)

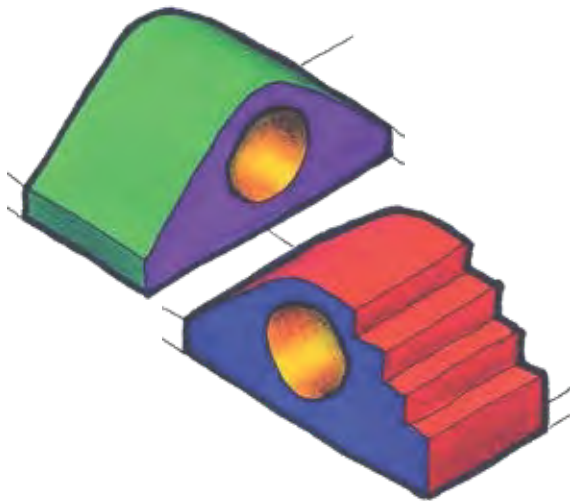

Hill and Steps & Slope Tunnels



Both are designed as stand alone pieces for children to clamber on and crawl through. Good within small and large areas.

Code	Product
0414-071	Hill Tunnel – 57" x 29" x 30" (145cm x 73cm x 75cm)
0414-072	Steps & Slope Tunnel – 57" x 29" x 30" (145cm x 73cm x 75cm)

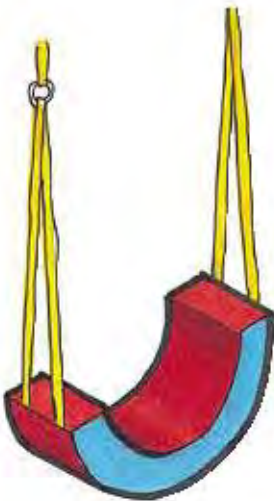

Horseshoe Swing



A supportive swing seat, the Horseshoe can be used in many ways: sit on traditionally, straddle or support your chest and stomach while swinging. Completely soft on the outside, it has a sturdy timber sub-frame.

Suspension brackets are not included.

Code	Product
0414-045	Horseshoe Swing

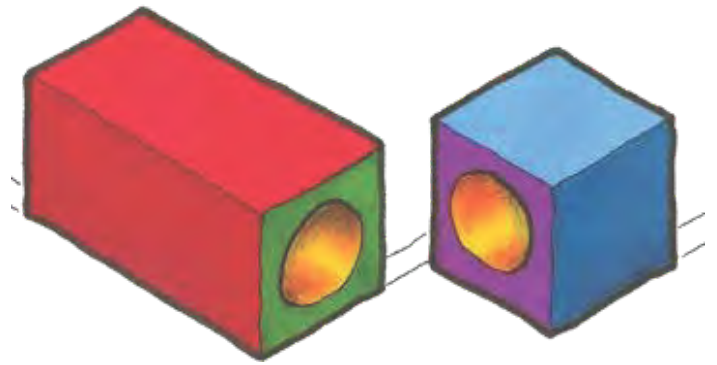

Tunnel Blocks



Good for crawling through, clambering and jumping on. Designed to work with Steps, Slope, Stepping Stones or Balance Beam.

Code	Product
0414-073	Short Tunnel Block – 29" x 29" x 30" (73cm x 73cm x 75cm)
0414-074	Long Tunnel Block – 57" x 29" x 30" (145cm x 73cm x 75cm)



Rainbow and Zebra Log Cushions



A different sort of Floor Cushion to balance, roll, jump and crawl about on.

Code	Product
0414-131	Rainbow Log Cushion – 57" x 29" (145cm x 73cm)
0414-132	Rainbow Log Cushion – 57" x 57" (145cm x 145cm)
0414-133	Rainbow Log Cushion – Special Size
0414-135	Zebra Log Cushion – 57" x 29" (145cm x 73cm)
0414-136	Zebra Log Cushion – 57" x 57" (145cm x 145cm)
0414-137	Zebra Log Cushion – Special Size

Soft Play

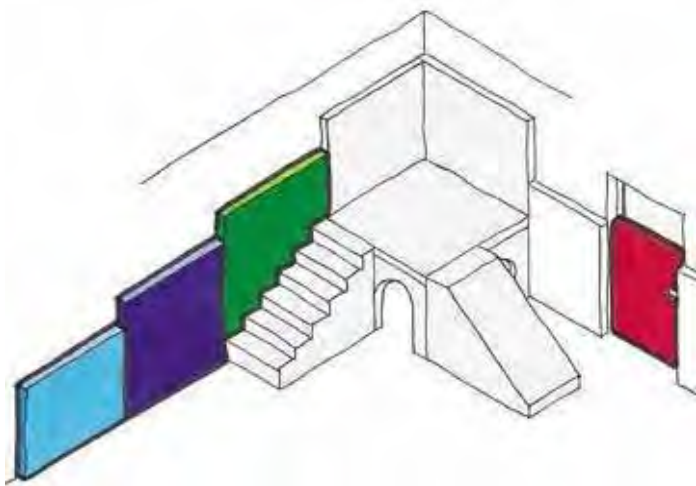

Wall Cushions



Low, Medium and High Wall Cushions are fixed to all vertical surfaces, the height depending upon the age of the users, the position within the room and the height of the adjacent Soft Play structures. Standard Cushion width is 57" (145cm), but they are usually manufactured to suit the exact dimensions of your room. All Wall Cushions are 3" (8cm) thick and Curved top and dual colored cover options offer greater possibilities to tailor the Cushions to your preferences and offer a more enticing aesthetic too.

Code	Product
0414-001	Low Wall Cushion – 50" high x 57" wide (127cm x 145cm)
0414-002	Medium Wall Cushion – 57" high x 57" wide (145cm x 145cm)
0414-003	High Wall Cushion – 69" high x 57" wide (175cm x 145cm)
0414-005	Other widths and heights to suit the size of the room
0414-009	Shaped and multi-color Wall Cushions



Soft Rocker



This is an extremely rigid yet completely soft structure with a bent plywood core. It can be used on top of Floor Cushions and gives you a good rocking movement. If turned upside down, it can also be used as a small bridge.

Size: 57" x 24" x 22" deep (145cm x 60cm x 56cm).

Code	Product
0414-047	Soft Rocker



Wigwam



Comes in 3 pieces: a permanently positioned base, a soft padded pole and the Wigwam walls (in one piece) which clips to the corners of the base.

Simple to erect and designed to be constructed and dismantled as part of the play session, the Wigwam is a wonderful piece for promoting role play and social skill development.

Code	Product
0414-036	Wigwam – 57" x 57" x 59" (145cm x 145cm x 150cm)



Hanging Sausage



These 59" (150cm) or 79" (200cm) long cylinders can be used as swings (by hanging on to them with arms and legs) or as climbing poles. They are very good punching bags too! (Fixing brackets are not included).

Fixing position and suspension system will depend upon the structure of the building. Please call 1 877 232 3320 for advice.

Code	Product
0414-043	Hanging Sausage – 59" x 12" diameter (150cm x 30cm) (Med)
0414-044	Hanging Sausage – 79" x 12" diameter (200cm x 30cm) (Long)



High Log Slope



A wonderful and colorful structure for clambering up and down on, using every part of your body. It can be made in any color combination.

Code	Product
0414-124	High Rainbow Log Slope – 57" x 29" x 41" (145cm x 73cm x 105cm)
0414-125	High Zebra Log Slope – 57" x 29" x 41" (145cm x 73cm x 105cm)



Hut



An extremely rigid and robust structure of timber and plywood that is completely cushioned on all the exterior surfaces. The roof will support the weight of 4 adults. A door and a window space give access to the inside, with enough room for 2 adults or up to 4 children. It has a cushioned floor and natural finish plywood walls. You can fix curtains and mirrors and decorate the inside walls to create an intimate personalized space for all sorts of pretend play. Also see the Infinity Huts, page 104-105.

Code	Product
0414-031	Hut – 57" x 57" x 41" (145cm x 145cm x 105cm)
0414-051	Infinity Hut Light Stars with Soft Platform Roof 57" x 57" x 41" (145cm x 145cm x 105cm)
0414-055	Infinity Hut – Light Panel with Soft Platform Roof
0414-053	Hut and Infinity Hut special sizes

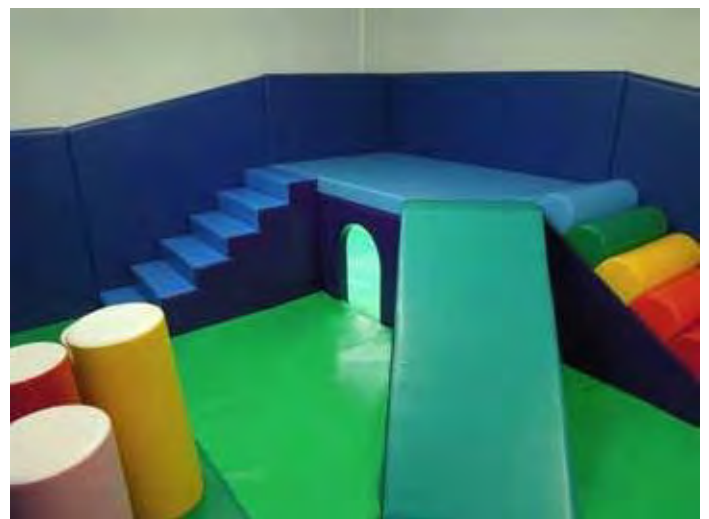

Soft Play



Jungles



Seven 'trunks' set in shallow holes. In its complete form it is a forest of trees to run, hide, hit and tumble about in. The 'trunks' can be removed and used as sausages, rollers and building blocks, while the base can be used for nests, stepping in holes, balancing and various soft ball games and aiming practice. Geometric Jungle – as above, but the 'trunks' and holes are various shapes, including, round, square and triangular.

Code	Product
0414-032	Jungle – 57" x 57" (145cm x 145cm)
0414-034	Geometric Jungle – 57" x 57" (145cm x 145cm)



Balance Beam



Rigid, but soft and safe. Great care has been taken in the design and manufacture to ensure that the foam and fabric do not slip or twist when in use.

It is great for crawling along, balancing, gymnastics and jumping off, giving an opportunity for 'risk taking' within a safe environment.

Code	Product
0414-040	Balance Beam – 89" x 8" x 30" high (218cm x 20cm x 75cm)
0414-041	Balance Beam – 114" x 8" x 30" high (290cm x 20cm x 75cm)
0414-042	Special size Balance Beam



Low Kerb



Used as a fixed edging block in doorways and open edges to Soft Play area and screwed firmly to the floor, Low Kerbs help prevent enclosed mats from moving out of position during use. Size: 3" (20cm) wide x 6" (15cm) x required length.

Code	Product
0414-019	Low Kerb (per yard)

Shoe Boxes and Seats



Special Shoe Boxes, Seats and Storage Cabinets are made to fit each Soft Play Room. They are usually positioned in a hard floor area adjacent to the entrance of the room.

Sizes and prices vary according to the design of the room.



Stepping Stones

16 high-density foam blocks of different heights and colors create a cluster of soft boulders to clamber over, jump off, balance on or play many color and co-ordination games.

They are also available with 8 blocks, or made to any specific size. **Shapes Stepping Stones.** Includes a Dice with shapes on the faces. These give new and exciting possibilities for the use of the steppingstones. They are wonderful for games, coordination and school curriculum work.

Musical Stepping Stones. Identical to the standard stepping stones, but each block has a musical note activated by light pressure on it. Choose any of a large number of different instruments and control the volume. Wonderful for encouraging coordinated movement and for playing musical games within a Soft Play Room.

Code	Product
0414-061	Stepping Stones (16 blocks)
0414-062	Half Stepping Stones (8 blocks)
0414-063	Musical Stepping Stones (16 blocks)
0414-064	Shape Stepping Stones and Dice (16 blocks)
0414-065	Shape Stepping Stones and Dice (9 blocks)



Soft Play

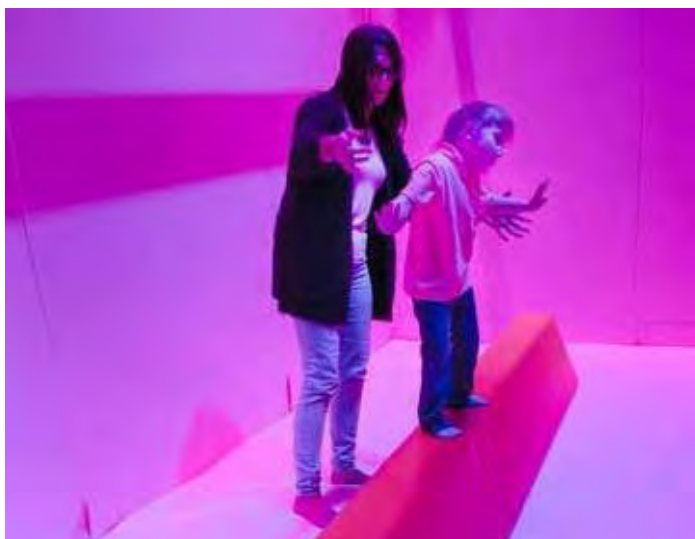

Low Balance Beam



This is a low level Beam that is completely soft but with timber reinforcement within to prevent distortion under adult weight. Sitting on top of the floor cushions, the Low Balance Beam is portable within the space and is wonderful for encouraging balance, stepping, jumping and sitting astride. Size: 13.5" x 12" x 57/86/114" long (35cm x 30cm x 145/218/290cm).

Code	Product
0414-161	Low Balance Beam – 57" (145cm) long
0414-162	Low Balance Beam – 86" (218cm) long
0414-163	Low Balance Beam – 114" (290cm) long
0414-164	Low Balance Beam – Custom Length

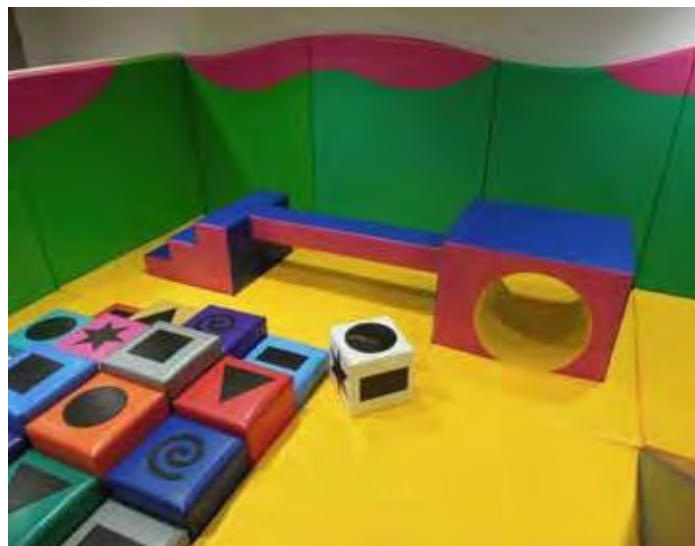

Step Beam Tunnel



This combination of activities creates a mini-gym in your Soft Play Room. It is very stable and robust but completely soft. Climb up the stairs, balance on the beam and jump off the platform, then crawl through the tunnel and negotiate your way under the beam.

Size: 29" (73cm) wide x 30" (75cm) high x 114" (290cm) long (length can vary to fit your space).

Code	Product
0414-076	Step Beam Tunnel Combination



Soft Play Trampoline



Specifically designed to fit in Soft Play spaces, this small trampoline has a robust frame surrounded by cushions for additional safety.

Code	Product
0414-081	Soft Play Trampoline – 57" x 57" (145 x 145cm)



Soft Building Blocks



These beautifully colored Soft Building Blocks can be used to construct creative structures or form obstacle courses within your Soft play Room. Ideal for promoting collaborative play and learning about shape and color. Size of Blocks: 12 x 12 x 12" (30 x 30 x 30cm) up to 12 x 6 x 24" (30 x 15 x 60cm)

Code	Product
0414-144	Set of 12 Soft Building Blocks

Opti Projectors and Visual Effects



NEW – Opti Aura Projector

Create your own home sensory environment using this amazing multi-effect projector. Using the same effects found in sensory rooms across the world, the new [Opti] Aura Projector has been designed specifically as an affordable item for your home. Providing wonderful effects in your bedroom, lounge or anywhere in the home, the Aura Projector can be pointed in any direction, even on to the ceiling and benefits from a contemporary, spherical design to ensure it is attractive in any setting.

- The Aura has a dimmable function and off timer capabilities
- The Projector comes with one 6" (15cm) Effect Wheel that fits easily on the integral wheel rotator
- Over 200 effect wheels to choose from
- Additional wheels are available to purchase separately
- A table and wall mount with fixtures and fittings is also included

Code	Product
0734-025	Aura LED Projector – with 1 Projection Wheel



Opti Sensory 100 LED Projector

The OPTI Sensory 100 LED is the smallest, quietest, safest and most economical 'bright light' effects projector in the Optikinetics range. Designed for multi-sensory effects projection in smaller therapy rooms and private homes, this silent running 12V projector punches above it's weight and can be used in other environments for effects or gobo projection to set the mood, inform or promote.

The light for the Sensory 100 LED is supplied by a 1400 lumen, energy efficient 20W LED module that lasts for over 100,000 hours with a high color temperature, concentrated through Optikinetics' unique optical system, for truer color projection and better image clarity than any other comparable projector on the market.

A Wheel or Cassette Rotator is required to attach effects to the Opti Sensory 100 LED Projector.

Code	Product
0734-009	Opti Sensory 100 LED Projector





Opti Sensory LED Projector

Projectors are one of the most basic and versatile pieces of equipment used for multi-sensory work. This NEW LED projector is as bright as the original Solar 250, it is also much cooler, quieter, weighs less, does not spill as much unwanted light and you never need to replace lamps. This projector also has the unique feature of having sockets enabling you to plug in Switches to turn the image ON and OFF and START and STOP the rotation of the effects wheel. It can project moving images over a whole wall, or with the use of rotating prisms and mirrors, around a whole room. It can also project onto a very small area to create a focal point for visual, cause-and-effect and choice-giving work.

Projectors can be used for shadow work, theming an area, art and technology (by creating your own wheels), numeracy work, literacy work as well as storytelling too. There are a wide range of wheels, cassettes, lenses and attachments, which allow very varied use.

A Wheel or Cassette Rotator is required to attach effects to the Opti Sensory LED Projector.

Code	Product
0734-007	Opti Sensory LED Projector – standard lens
0734-008	Opti Sensory LED Projector – wide angle lens



See more projectors on page 99



Mathmos Space Projector



3D Laser Star Projector

Opti Projectors and Visual Effects



Lenses

A range of spare and optional lenses for the Opti Projectors. A standard 3.3" (85mm) lens is supplied with the projector.

The **Wide Angle Lens** creates a larger image and is good for use in small rooms.

The **Kaleidoscope Lens** splits any image, creating a snowflake of movement and color. It is good for encouraging visual focus and wonderful for viewing home-made pattern wheels.



Code	Product
0734-005	Standard Lens 3.3" (85mm)
0734-006	Wide Angle Lens 2.4" (60mm)
0734-031	Kaleidoscope Lens

Wheel and Cassette Rotators

Effect wheels must be used with the **Wheel Rotators** in the projectors. There are three different speeds of wheel rotator for the 6" effect wheels:

Ultra Slow Rotator, for story telling and talking about the images.

½ RPM Rotator, for most uses. Shows clear movement of projected images.

5 RPM Rotator, for fast moving images.

Wheel Safe Rotator has a metal casing and is best for protecting Liquid Wheels which are made of glass and are therefore fragile. (Does not fit Solar 100 Projector)

Cassette Rotator, for animating pattern cassettes.

Max Rotator, for use with the Max Effect Wheels

Dual Wheel Rotator is designed to fit both Standard 6" (15cm) Wheels and 9" (23cm) Max Wheels.

It also has variable speed control, from 1 revolution in 50 minutes up to 5 revolutions in 1 minute.

Please note that you should only use the Rotator at very slow speeds with the Opti LED Projectors. (Projectors with halogen lamps create heat, which may damage the wheel at very low speed.)

The Dual Wheel Rotator fits all Opti and Solar Projectors (except the Aura Projector which has a built in rotator).

Code	Product
0734-011	Ultra Slow Wheel Rotator
0734-012	½ RPM Wheel Rotator
0734-013	5 RPM Wheel Rotator
0734-014	½ RPM Wheel Safe Rotator
0734-022	2" (50mm) Cassette Rotator
0734-018	Max Wheel Rotator (6 minute)
0734-015	Dual Wheel Rotator





Mirrors and Prisms

A range of accessories which fit on the front of all Opti Projectors, enabling you to split and move images around the room.

The **Deflector Mirror** allows images to be projected onto the ceiling, floor or walls adjacent to the projector.

The **Panoramic Rotator** fits onto the lens of the projector and splits and sends the image rotating around the room.

Clip-on Prisms fit onto the lens of the projector and divide the projected image into 2, 3 and 4 different images respectively.

The **Multi-facet Mirror** fits on to the lens of the Opti Sensory Projector. It is a less expensive option to the Multi-Mirror and gives a fragmented image effect, but without the moving mirror head.

Code	Product
0734-032	Panoramic Rotator
0734-033	Deflector Mirror
0734-034	Clip-on Prism – 2-facet
0734-035	Clip-on Prism – 3-facet
0734-036	Clip-on Prism – 4-facet
0734-045	Opti Multi-Facet Mirror



Multi-Mirror



The Multi-Mirror fits on existing projectors and gives a wonderful movement and depth when used with the abstract wheels. It creates such effects as snow storms, autumn showers and galaxies of moving stars. It is almost like a 'video' effect, creating wonderful backdrops for themes.

Code	Product
0734-043	Opti Multi-Mirror

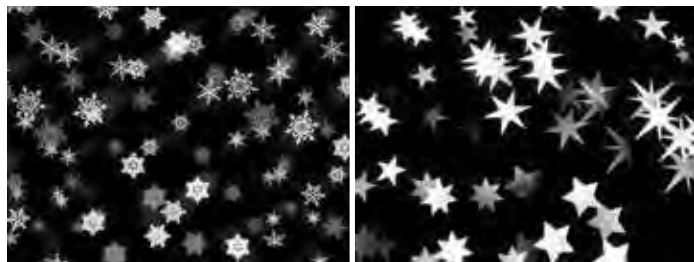

Opti Magnet Wheel Adaptor Kit



If you do not have a Magnetic Wheel Rotator – don't let that stop you trying or switching to Magnetic Wheels. The Magnetic Wheel Rotator Adaptor turns your existing 'spindle drive' Wheel Rotator into a Magnetic Wheel Rotator

Code	Product
0734-017	Opti Magnet Wheel Adaptor Kit

Opti Projectors and Visual Effects

Projection Pattern Wheels 6" (15cm)

Pattern Wheels present moving visual images, which can be used for theme and curriculum work, relaxation, communication and storytelling and many other purposes within multi-sensory work. All wheels are plastic and safe to use in Sensory Rooms. Pattern Wheels must be mounted on a Wheel Rotator when used in any Projector. All Wheels will fit Opti Sensory Projectors and the Aura Projector.

Code	Product
0734-***	Individual Pattern Wheels Please state specific wheel name and code (as shown below image)
0734-798	Set of 5 different Pattern Wheels Select any 5 from the range



0734-702
Balloons



0734-739
Avalon Dawn



0734-701
Aviation



0734-704
Cloud

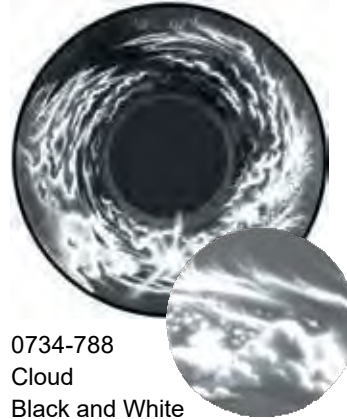

0734-788
Cloud
Black and White



0734-747
Cog

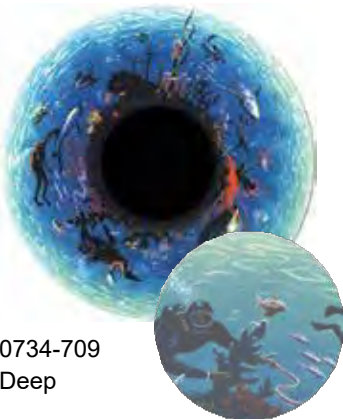

0734-709
Deep



0734-713
Flags



0734-712
Earthquake



0734-714
Fire



0734-715
Fireworks



0734-723
Munchies



0734-763
Graffiti



0734-718
Inner Space



0734-735
Zodiac



0734-729
Prehistoric



0734-720
Safari



0734-730
Shapeland



0734-732
Space
Ritual



0734-787
Wildlife Black
and White



0734-736
2001

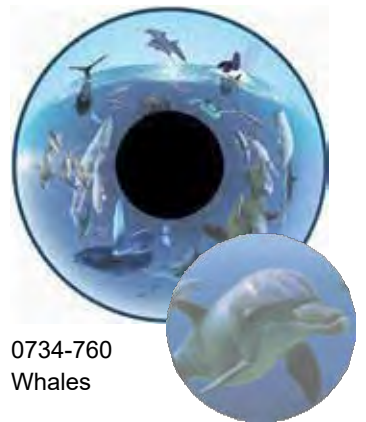

0734-760
Whales



0734-753
Tropical
Fish



0734-764
Tropical
Birds



0734-770
Butterflies



0734-772 In
the Country



0734-765
Quest



0734-727
World



0734-725
Weather



0734-791
Seasoned
Woods

Opti Projectors and Visual Effects



0734-707
Birthday



0734-734
Camouflage



0734-710
Countryside



0734-717
Floral



0734-761
Flowers



0734-762
Fluffy
(Animals)



0734-766
Ghost



0734-719
Jigsaw



0734-721
Motorcycles



0734-746
Outdoor
Ball Sport



0734-731
Picnic



0734-728
Seaside



0734-740
Sunrise
Cloud

Reminiscence Projection Wheels

A range of Projector Wheels specially designed to encourage memory and communication about time gone by. Liquid Wheels and many other wheels can also be used to create a relaxing environment. Requires a Wheel Rotator to work with Opti Projectors (except the Aura Projector).

Code	Product
0734-741	Musical Stars 1930s to 50s 6"(15cm) Wheel
0734-742	1930s to 1940s Films 6"(15cm) Wheel
0734-733	1940s Film Stars 6"(15cm) Wheel
0734-744	1940s to 1960s 6"(15cm) Wheel
0734-792	Stained Glass 6"(15cm) Wheel
0734-759	Thames 6"(15cm) Wheel
0734-743	1950 Film Star Cards 6"(15cm) Wheel
0734-978	1936 to 1945 Max Wheel
0734-979	Vintage Products Max Wheel
0734-980	Sports Star Cards Max Wheel
0734-798	Set of 5 different 6"(15cm) Pattern Wheels Select any 5 from the range
0734-998	Set of 5 different Max Effect Wheels Select any 5 from the whole range



0734-733
1940s Film Stars



0734-741
Musical Stars 1930s - 50s



0734-742
1930s - 1940s Films



0734-743 1950 Film Star Cards



0734-744
1940s - 1960s

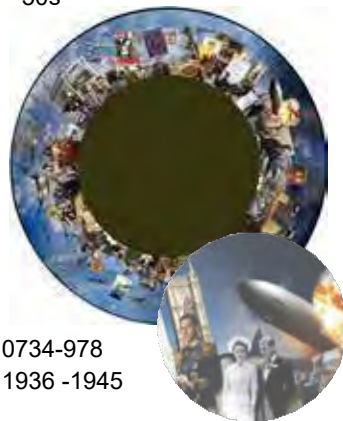

0734-978
1936 - 1945



0734-979
Vintage Products



0734-980
Sports Star Cards



0734-792
Stained Glass

Opti Projectors and Visual Effects

Early Learning Wheels 6" (15cm)

This series of wheels are specially designed with basic objects and subjects, as an aid to early learning and communication. Requires a Wheel Rotator to work with Opti Projectors (except the Aura Projector).

Code	Product
0734-***	Early Learning Wheels Please state specific wheel name and code (as shown below image)
0734-798	Set of 5 different Early Learning Wheels Select any 5 from the range



0734-420
2D Shapes

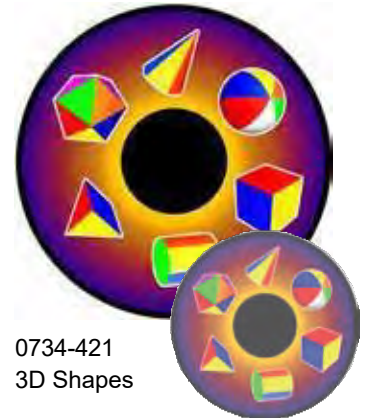

0734-421
3D Shapes



0734-423
Animals



0734-424
Balloon Festival



0734-425
Balls



0734-426
Family Pets



0734-427
Fruit



0734-428
Jurassic Park



0734-429
Salad Vegetables



0734-431
Vegetables



0734-432
ABC



0734-435
Farm Animals



0734-437
People of the World



0734-438
Road Transport

Abstract Wheels (multi-directional effects)

This is a series of wheels that can be used on their own, but are best used in conjunction with a Opti Multi-Mirror or a Multi-Facet Mirror. They give a wonderful movement and depth and create such effects as snow storms, autumn showers and galaxies of moving stars. It is almost like a video effect, creating wonderful backdrops for themes.

Requires a Wheel Rotator to work with Opti Projectors (except the Aura Projector).

Code	Product
0734-***	Individual plastic Pattern Wheels 6" (15cm) Please state specific wheel name and code (as shown below image)
0734-798	Set of 5 different plastic Pattern Wheels 6" (15cm) Select any 5 from the range
0734-043	Solar Multi-Mirror
0734-045	Opti Multi-Facet Mirror

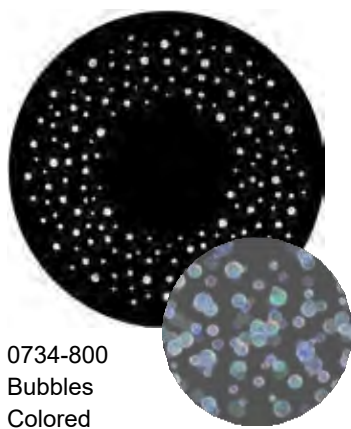

0734-800
Bubbles
Colored

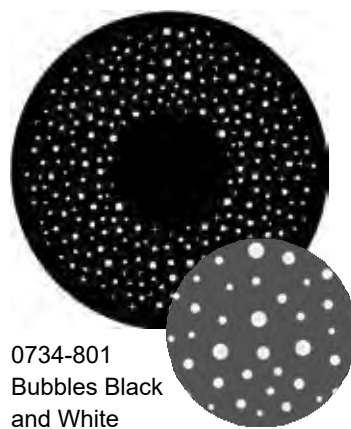

0734-801
Bubbles Black
and White



0734-802
Papillon
Colored

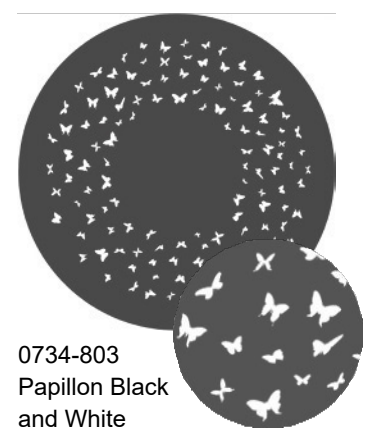

0734-803
Papillon Black
and White



0734-804
Leaf
Colored



0734-805 Leaf
Black and White



0734-806
Spores
Colored

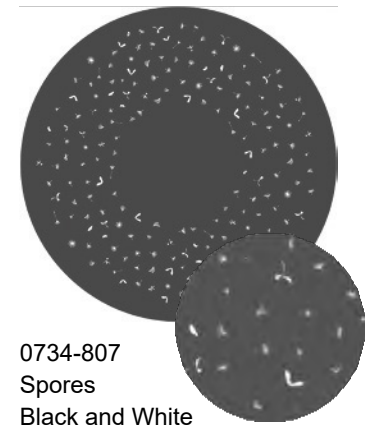

0734-807
Spores
Black and White



0734-808
Galaxy
(Stars)

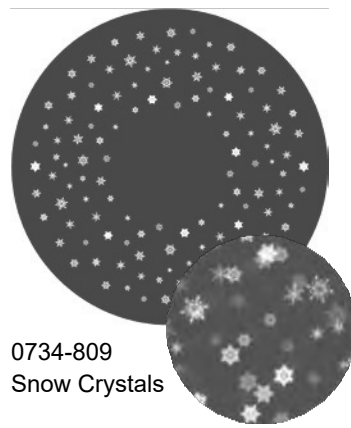

0734-809
Snow Crystals



0734-810
Blossom
Colored

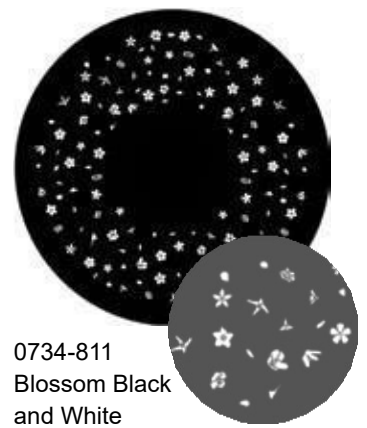

0734-811
Blossom Black
and White

Opti Projectors and Visual Effects

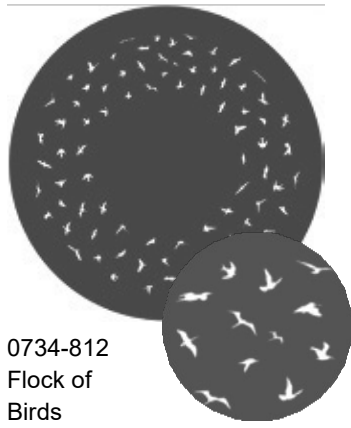

0734-812
Flock of
Birds



0734-813
Flying Pigs



0734-815
Candles



0734-817
Love Hearts

Max Effect Pattern Wheels

The Max Effect Wheels project a larger range of images and content because of the increased area of the wheel.

This is a range of 14 enhanced photographic wheels, each with about twice as many images as the traditional 6" (15cm) wheel, and of a much higher definition. When used with the Max Rotator or Dual Wheel Rotator it can have up to a 6 minute rotation. It will create wonderful moving scenes.

Code	Product
0734-***	Individual Max Effect Wheels Please state specific wheel name and code (as shown below image)
0734-998	Set of 5 different max Effect Wheels Select any 5 from the range



0734-967
Meadow



0734-968
Farming

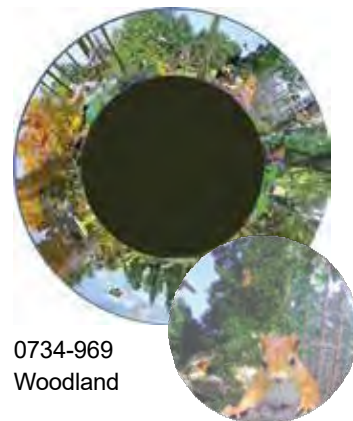

0734-969
Woodland

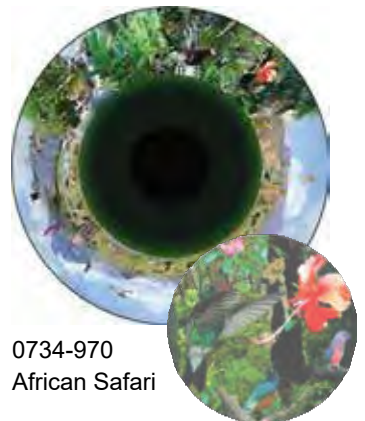

0734-970
African Safari

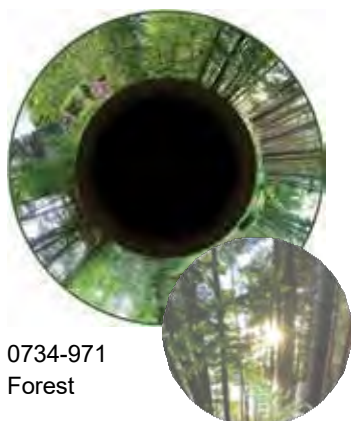

0734-971
Forest



0734-972
Day and
Night Sky



0734-973
Aquarium



0734-974
Coral Reef

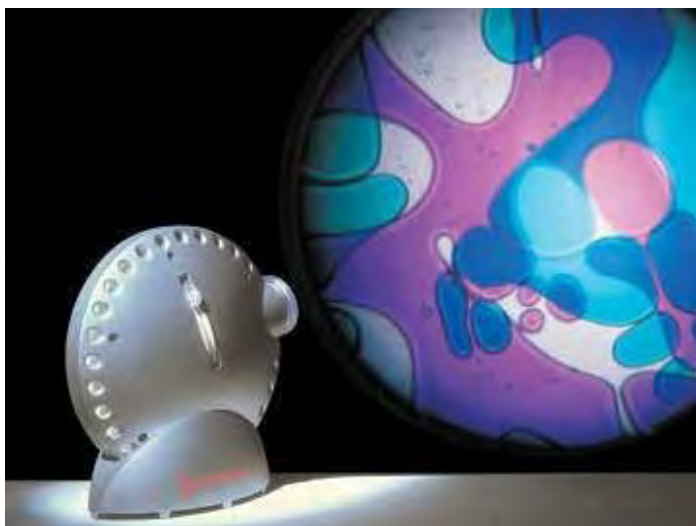

Mathmos Space Projector

Ideal for home use, in a small sensory room or as a portable piece of equipment to use with the Projection Brolley, the Space Projector is an economic alternative to the Opti Projectors.

Further activity is available if used with Switch2 Control Units and additional Liquid Wheels offer different colors to suit the session theme or the preference of the user.

Each unit is supplied with the Blue/Red Liquid Wheel.

Code	Product
0949-001	Mathmos Space Projector, Blue/Red
0949-102	Liquid Wheel – Blue/Green
0949-103	Liquid Wheel – Blue/Yellow
0949-104	Liquid Wheel – Violet/Green
0949-105	Liquid Wheel – Violet/Red
0949-106	Liquid Wheel – Red/Yellow
0949-107	Liquid Wheel – Violet/Blue
0949-108	Liquid Wheel – Blue/Red
0949-109	Liquid Wheel – Clear/Clear
0949-114	Set of 4 different Colored Wheels Select from range above
0949-110	Spare lamp for Space Projector



3D Laser Star Projector

The 3D Laser Star projector projects a wonderful night sky effect onto the walls and ceiling. A cluster of blue misty clouds drift around while bright green stars move across the sky. The Projector needs no setting up and is good for night-time and relaxation as well as for creating outer-space themes. The projection covers a large area.

Code	Product
0949-201	3D Laser Star Projector

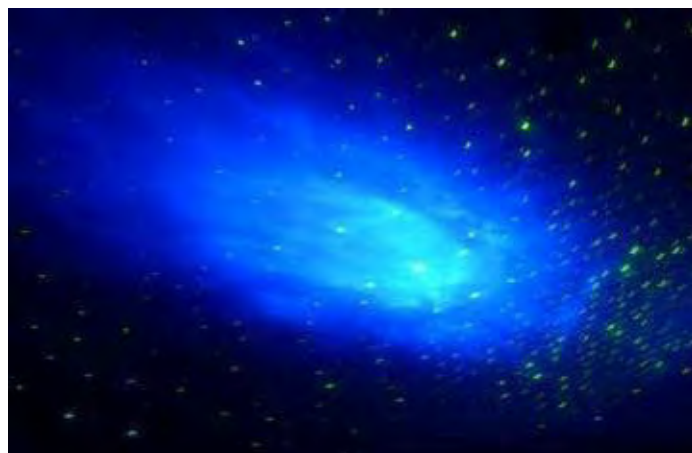

A really useful tip

Storing Projector Wheels and Motors is always a problem, so here's a very simple idea.

Take a number of the styrene packing pieces for the 6" (15cm) wheels and tape them together with duct tape. This makes a rack that will keep your wheels clean and tidy. You can also place large wheels in them but they won't fit perfectly.



Projection and Light Effects



Pinspot Lights and Color Wheels

A Pinspot creates a narrow beam of light to focus on Mirror Balls, reflective objects or small areas on the wall. The Color Wheel provides a gentle color change to the spot of light. When used with a Mirrorball, all the reflected spots of light will gently change color as they move around the room. The Portable Pinspot can be used anywhere in the room. It can be plugged into a Switch2 Control Point and used for cause and effect work.

Code	Product
0715-001	Pinspot with lamp
0715-002	Pinspot and Color Wheel with lamp
0715-011	Portable Pinspot with lamp
0715-012	Portable Pinspot and Color Wheel with lamp
0715-101	Spare Lamp for Pinspot – 35 watt



Mirror Balls and Motors

Mirror Balls are one of the most commonly found pieces of equipment in Sensory Rooms, mostly used in conjunction with a Pinspot Light. For extra spots of light try using two Pinspots aimed onto the Mirrorball from different positions. But have you tried it with a projector focused onto it or just placed it in a pool of sunlight? The Portable Mirror Ball can be used almost anywhere, just plug into a 13amp socket. This model has a 1/2 RPM motor, a speed we recommend for relaxation and visual tracking. Note: For visual comfort it is better to position Mirror Balls towards one side or corner of a room.

Code	Product
0716-001	8"(20cm)diameter Mirror Ball and Motor – 2 RPM
0716-002	12"(30cm)diameter Mirror Ball and Motor – 2 RPM
0716-003	16"(40cm)diameter Mirror Ball and Motor – 2 RPM
0716-004	8"(20cm) diameter Mirror Ball and Motor – 1/2 RPM
0716-005	12"(30cm)diameter Mirror Ball and Motor – 1/2 RPM
0716-006	16"(40cm)diameter Mirror Ball and Motor – 1/2 RPM
0716-011	Portable Mirror Ball with 1/2 RPM Motor



Soft Play Color Swatches

Swatch 1

Soft Play (and optional Bean cushion cover) fabric Extremely tough, PVC, nylon reinforced, fire retardant fabric. Cape grain texture, in 23 colors.



1. White
2. Cream
3. Yellow
4. Light Orange
5. Orange
6. Red
7. Magenta
8. Pink
9. Lilac
10. Purple
11. Dark Blue
12. Medium Blue
13. Light Blue
14. Ice Blue
15. Turquoise
16. Light Green
17. Medium Green
18. Dark Green
19. Brown
20. Fawn
21. Grey
22. Silver
23. Black

Swatch 2

Agua-fabric is a soft, textured and slightly patterned fabric that is extremely hardwearing, colorfast, wipe clean, waterproof, anti- fungal and fire retardant. In 20 colors.

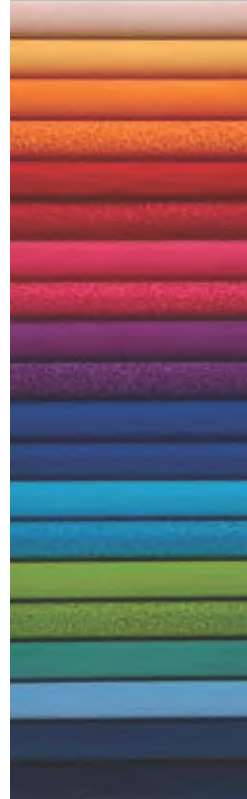

1. Coffee
2. Tan
3. Orange
4. Orange Speckle
5. Red
6. Red Speckle
7. Cerise
8. Cerise Speckle
9. Purple
10. Purple Speckle
11. Blue
12. Blue Speckle
13. Turquoise
14. Turquoise speckle
15. Lime
16. Lime Speckle
17. Green
18. Light Blue
19. Dark Blue
20. Navy

Swatch 3

A soft textured, extremely durable polyurethane coated fabric, that feels wonderful to touch and is waterproof and fire retardant. In 11 colors.



1. Aqua
2. Berry
3. Black
4. Brown
5. Lime
6. Orange
7. Pink
8. Red
9. Royal
10. White
11. Yellow

We make every effort to give you a true representation of the colors and description of the fabrics, but there may be some difference between the printed, screen image and the actual fabrics. If the color is critical, we can provide sample pieces and swatches.

Multi-Sensory Rooms



Sensory Integration



6

Immersive Spaces



Switch Access and Control

Sensory Activities



Safe Areas and Rooms



Tactile Experience

Soft Play Rooms



SensoryOne

8695 Escarpment Way
Unit 7
Milton, ON
CANADA
L9T 0J5

Phone: 1-877-232-3930 ext 701
E-mail: customerservice@sensoryone.com
Web: www.sensoryone.com



SensoryOne
Sensory Room Specialists